

**mafi**

# PRICELIST 2024

EN International

# **mafi**

## natural wood floors

stable · natural · healthy

Stability in a wide variety of climatic zones and areas of application means long-term product quality and flexibility. Therefore, we produce our planks in a symmetrical 3-layer construction using the same wood for top and back layers.

Man and wood harmonize and should not be separated. mafi promotes direct, genuine contact with wood and thus finishes floorboards with natural, air-dried oils.

Our wooden floors combine a pollutant-free product with a health-promoting effect. The unique, breathable surface improves your indoor climate in a sustainable manner.

Valid from 08.07.2024



online version pricelist



LIVING  
PRODUCT  
CHALLENGE



reddot design award  
winner 2012



Approved by the National Asthma Council  
Australia's Sensitive Choice™ program

expired



reddot design award  
honourable mention 2009



mafi is FSC® certified.  
Products with FSC®  
certification are  
available on request.



Upper Austria 2011  
WINNER IN THE CATEGORY EARTH



# General Information

With this price list, all previous editions are invalid. Error, price and technical changes reserved. For any questions, we are happy to help you.

Variations in colour and structure are natural characteristics of wood. Wood structure, colour and any proportion of sapwood vary constantly due to the availability of raw material. For further information, please contact our team. Printing-related colour differences in the price list are, in principle, not excluded and represent no reason for complaints compared to the real wood floor.

mafi sorts according to the "free class" standard, EN13489 Appendix B. For special characteristics of the sorts of individual products, please refer to the corresponding product descriptions. Unless separately noted, the product description applies to both planks and wide-planks of the same product.

For technical specifications such as underfloor heating suitability, application areas, emission classes, fire behaviour, etc. please refer to the footer of the respective price list for each relevant product. You will also find detailed information in the product data sheets at mafi.com.

## Returns and surplus deliveries

Due to the customised flexible ordering options, no planks or packages may be returned. A mafi natural wood floor is designed specifically for you or your customers according to your order specifications with a lot of handcraft. Due to variable dimensions, it is unfortunately not always possible to produce your orders to the exact amount. Therefore, there may be up to a maximum of 3 % surplus material delivered or invoiced. When ordering fixed lengths, a maximum of 2 % of the ordered quantity may differ from the ordered fixed length.

## mafi Passport

For all products according to the price list a mafi passport for end customers is handed over along with your delivery note. This passport includes a registration code for the authentication of the mafi natural wood floor as well as care instructions. On the passport there is a delivery confirmation, with which you can confirm the handing over of these care instructions.

Each customer must receive mafi care instructions, which are already enclosed with the offer.

## Shipping information

**Please note the following checklist for direct deliveries:**

- Approach possible for semitrailer? (Note access roads)
- Forklift or staff available for unloading?
- Local contact person and cell number available?

In case of non-compliance, we reserve the right to charge any additional costs. Outside of Austria and Germany, ground sales are usually FCA Schneegattern, Austria.

# Packaging, transport and surcharges

mafi natural wood floors are delivered per standard as packages packed in cardboard, fixed with a plastic band and foil, and on stacked lumber. Due to our order-related production, the period between the end of production and pick-up is to be kept as short as possible. Transport costs are charged separately. Prices are not discountable. We reserve the right to charge for any changes made after confirmed order confirmation on a time and material basis (minimum 50,- EUR).

## DELIVERIES

Minimum order:	25 m <sup>2</sup>
Shortfall minimum order:	50.- EUR processing fee

## PACKAGING

On pile of wood or pallet with edge protection:	0.50 EUR per m <sup>2</sup> of floor
IPPC box:	2.00 EUR per m <sup>2</sup> of floor
Express shipping (bubble wrap and/or sandwich panels):	30.- EUR per package
Special packaging:	on request

## STORAGE FEES

1 week past the end of production:	free
Beyond that:	70.- EUR per pallet started per week



## EXPORT

Export papers (certificate of origin, export accompanying documents, etc.):	150.- EUR
Phytosanitary Certificate:	200.- EUR
Country-specific inspections for import:	on request

# Ordering system

We have brought the delivery times to the point. No other floor manufacturer can deliver your custom-made floor faster! In the price list you will find our products marked with the following points.

**Please note the order deadline.** The daily closing time is 09:00 (CET) depending on the respective point and personal delivery date.

-  GREEN: Your personal mafi natural wood floor is from the 4<sup>th</sup> working day on its way to you!
-  YELLOW: Your personal mafi natural wood floor is from the 10<sup>th</sup> working day on its way to you!
-  RED: Sampling and delivery time on request, depending on the raw materials.  
Attention: order quantity of  $\geq 300$  m<sup>2</sup> per product = RED DOT!

## mafi.com online ordering

PRICE CALCULATED FROM / MARGIN CALCULATOR / AVAILABLE 24 HRS.

As an alternative to a written order, the mafi.com online ordering system is available for our partners. The shopping cart-based system automatically calculates any surcharges and provides information on the appropriate point system to calculate the delivery time. Requests can be converted in just a few seconds to offers or orders. Thanks to the structured data collection, all parties save time and reduce possible sources of error.

We are happy to inform you: [office@mafi.com](mailto:office@mafi.com)

# Article code system

The mafi article code system is flexible and depends on the options you choose. This code consists of the product, the surface treatment and the dimensions.



## Product

The first four digits identify the product: e.g. ECEB

## Surface

The next three digits identify the respective surface: e.g. BKN

Only certain surfaces are available per product. Further information is available on the corresponding product price list sheet. Special surfaces are available upon request. Not all combinations are technically feasible or sensible.

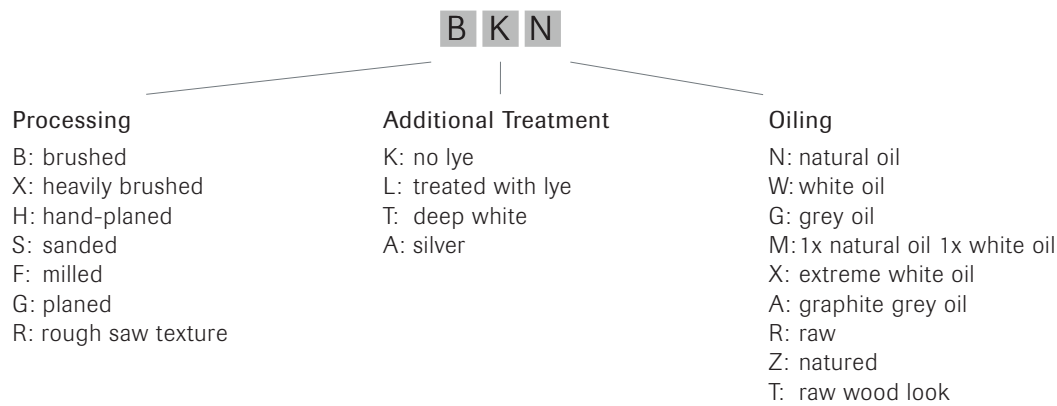

## Dimensions

The third part of the article code defines the dimensions of length, width and thickness. Variable dimensions are specified with 0. So, from the variable lengths 1800/2000/2400 the article code will be 0000. If a fixed length is set, 2400 will be used for example.

NEW: The spelling of variable dimensions also provides information if a selection is possible, and whether or not it is connected to a surcharge:

| = Selection possible without surcharge    / = Selection possible with surcharge    - = no selection possible, completely open  
 E.G.: Thickness: 16|19 mm    E.G.: Length: 1800/2000/2200/2400 mm    E.G.: Width: 120 - 225 mm

## Skirting

With mafi skirting boards the corresponding profile must also be selected in addition to the desired dimensions.

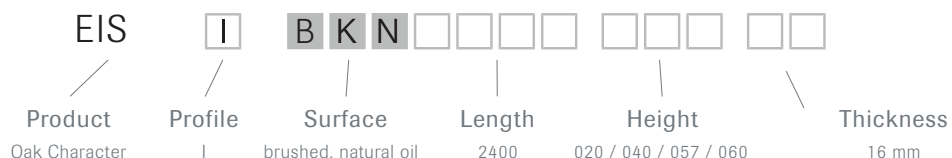

## Stairs and Parquet panel

Differing stair solutions are offered matching to the floor. In this price list you will find designated prices for Oak Clear, Oak Character, Oak Country and Oak Vulcano. Stairs for other mafi natural wood floors are available on request. For ordering stairs, the corresponding profile must be selected, as well as completely filling out the mafi stairs form (download option on mafi.com). The pattern for boarded parquet flooring is likewise selected via a profile selection from A to D.

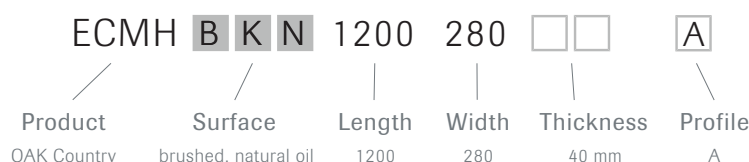

# Plank construction

## Symmetrical 3-layer construction

With symmetrical 3-layer construction both the top and back layers consist of the same type of wood. The top layer is approximately 4 mm. The cross-laid soft wood middle layer provides excellent shape stability - ideal for installation on underfloor heating. Exceptions:

**Tiger oak:** The top layer as well as the back layer has a thickness of approx. 3.5 mm.

**Riva:** Top layer with 3D surface approx. 2.5-4 mm thick, back layer approx. 3.5 mm.

**Fresco:** Top layer with 3D surface approx. 2.5-4 mm thick, back layer approx. 3.5 mm.

**Boiserie:** Initial thickness of the top layer approx. 4 mm. Due to the design, the top layer of Boiserie Reserve is milled into the recesses to a minimum. With Boiserie Linear, the top layer is completely removed in the recesses.

mafi uses only formaldehyde-free white glue. This is made from water, coal, chalk and acetic acid, and without solvents which could cause allergic reactions. White glue health hazards are not known. mafi uses no formaldehyde-containing substances. Therefore, our floor can be classified in the E1 classification (ÖNORM EN 14342).

Each plank is fitted with tongue and groove for endless installation. The mafi planks have a bevel on the long side. Laying formats such as herringbone, chevron and hexagon, as well as the boards for our parquet panel have a bevel all the way around.

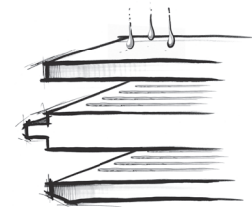
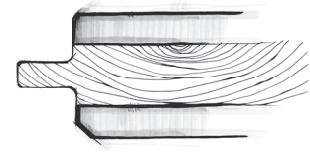

## Symmetrical 3-Layer Structure (Parquet panel)

Symmetrical 3-layer construction with a circumferential bevel as well as a tongue and groove on all sides for endless laying. Top layer, approx. 4 mm, consisting of quality select wood. Middle layer consisting of a 3-layer panel; white glue (PVAc) is used to stick it to the top and back layers. Back layer, approx. 4 mm, consisting of the same wood as the top layer.

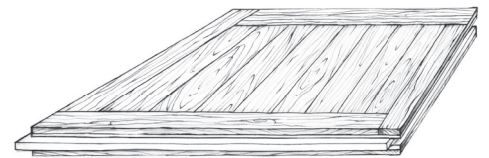

## Multi-layer construction (thin-plank)

The top and also the back layers are made from the same wood with the same thermo treatment. The top layer measures approximately 4 mm while the back layer is approx. 3 mm thick. For the middle layer, softwood elements positioned at 90° are used. The thin plank has a total thickness of 10 mm and is ideal for installations with low structure heights, as often found in renovations.

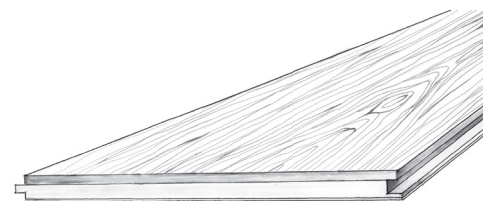

## Domino Vulcano Elements

Domino floors combine the advantages of the mafi Vulcano collection with modern design possibilities. Many parts produce a whole worth seeing that is inspiring thanks to vitality and style. Domino Vulcano elements are end-grain and cut across the trunk. The cubes (40 x 40 mm) are held together on a floor net and by gluing on a standardised underfloor result in a particularly hard-wearing floor suitable for the commercial interiors. Important: The installation may only be carried out exclusively by professionals. The mafi installation instructions must be adhered to.

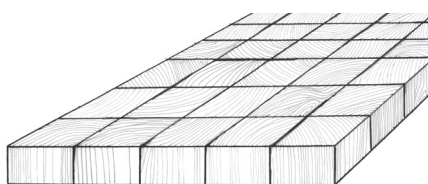

Top

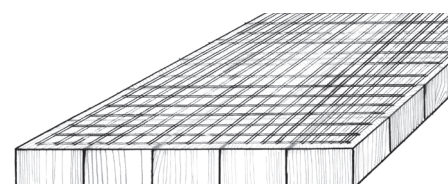

Bottom with floor net

# Dimensions

The lengths, widths, and thicknesses offered, vary from product to product. Possible variants can be inferred from the corresponding product detail page. Can't find the right thing? Just inquire at [office@mafi.com](mailto:office@mafi.com). As we are a manufactory we are able to do just about anything.

## Lengths

A lot of products are offered with accruing lengths. This systems primarily from our central idea of sustainability and the approach anchored in it to make the best possible use of the entire tree. Even visually, the mixed lengths provide an authentic design for cottage planks, especially when the planks are laid in a wild lattice. Fixed dimensions are generally possible for an additional surcharge. Please also note our room-length planks of four or five meters in length. Laying formats are produced from the plank material and have shorter lengths of 580–980 mm.

1000 | 1800 | 1980 | 2000 | 2200 | 2400 | 2480 | 3500 | 4000 | 4500 | 5000 mm

## Widths

Thanks to the symmetrical 3-layer structure, which guarantees stability, we offer a lot of products in widths up to 300 mm. The product range likewise includes timeless, elegant, and, above all, narrow planks of just 100 mm. The installation of mixed widths, which really prove effective particularly in our wide planks, is increasingly popular.

100 | 110 | 120 | 135 | 155 | 160 | 185 | 190 | 220 | 235 | 240 | 245 | 260 | 280 | 300 mm

## Thickness

We offer our natural wood floors in different thicknesses to provide our customers with maximum flexibility. The standard thicknesses are 16 or 19 mm. To achieve them, the thickness of the middle layer is changed, while the top and back layer thickness remains unchanged. Exciting features for renovation and modernization work include our thin plank with a low structure height of just 10 mm.

10 | 16 | 19 mm

## Dimension overview OAK (New widths)

With the validity of the new 2024 price list, standard widths of oak planks will be increased by 5 mm each. The change in widths affects the OAK products in the Tiger, Coral, Basic, Riva, Carving and Boiserie collections.

### Overview of dimensions Basic formats OAK



PLANK

New widths:  
160 | 190 | 245 mm

Lengths:  
1800 | 2000 | 2200 | 2400 mm



WIDE-PLANK

New widths:  
160 | 190 | 245 | 260 | 280 | 300 mm

Lengths:  
4000 | 5000 mm

### Overview of new dimensions OAK laying formats

HERRINGBONE 90°	HERRINGBONE 77°	CHEVRON 45°	CHEVRON 60°	HEXAGON
580 x 160 mm	630 x 160 mm	580 x 160 mm	600 x 160 mm	369,5 x 160 mm
780 x 190 mm	630 x 190 mm	580 x 190 mm	600 x 190 mm	
980 x 245 mm				



# Laying formats

## Available laying formats

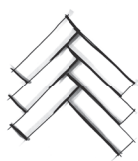

HERRINGBONE 90°



HERRINGBONE 77°



CHEVRON 45°



CHEVRON 60°



HEXAGON



FLEX

## Calculation with OAK

WIDTH	HERRINGBONE 90°	HERRINGBONE 77°	CHEVRON 45°	CHEVRON 60°	HEXAGON	FLEX
	580 x 160 mm 780 x 190 mm 980 x 245 mm	630 x 160 mm 630 x 190 mm	580 x 160 mm 580 x 190 mm	600 x 160 mm 600 x 190 mm	369,5 x 160 mm	
160 mm	14.40 €	18.00 €	27.60 €	22.80 €	28.80 €	66.00 €
190 mm	14.40 €	18.00 €	27.60 €	22.80 €		66.00 €
245 mm	14.40 €					66.00 €

## Calculation with ASH

WIDTH	HERRINGBONE 90°	HERRINGBONE 77°	CHEVRON 45°	CHEVRON 60°	HEXAGON	FLEX
	580 x 155 mm 780 x 155 mm 580 x 185 mm 780 x 185 mm	560 x 155 mm 760 x 155 mm 560 x 185 mm 760 x 185 mm	540 x 155 mm 730 x 155 mm 710 x 185 mm	550 x 155 mm 740 x 155 mm 550 x 185 mm 740 x 185 mm		
155 mm	14.40 €	18.00 €	27.60 €	22.80 €		66.00 €
185 mm	14.40 €	18.00 €	27.60 €	22.80 €		66.00 €
240 mm	14.40 €					66.00 €

Further products on request.

## Calculation example

Example calculation of surcharges for installation formats:

Price of the plank in the corresponding width + surcharge for laying format = EUR per m<sup>2</sup> for plank in the desired laying format

e.g. OAK Clear plank 190 mm + herringbone 90° surcharge = price for one m<sup>2</sup> herringbone 90° in OAK Clear plank 190 mm corresponds to 177,00 € + 14,40 € = 191,40 € / m<sup>2</sup>

# Applications

## Flex

mafi FLEX is available as an optional application for many of our products. The planks are already oiled once in the factory and prepared for bending. The precise processing makes the planks flexible up to a maximum radius of 40-60cm (which can vary depending on the type of wood and the type of installation).

**INSTALLATION:** The curved boards can be glued onto the carrier material or screwed/nailed using the tongue and groove. The carrier material is already in the desired radius. In order to make the bending of the planks easier, the wood must always be washed during installation with warm soapy water. This allows the wood to flex and the wood fibres become smoother. For the suitable mafi FLEX products and the relevant surcharges, please refer to the individual price list sheets.

## Custom Carving

### Your design on a real natural wood floor!

mafi's carving technology allows us to realize individual designs on your chosen floor.

Possible dimensions:	MAX	MIN
Plank length:	2400 mm	1800 mm
Plank width:	245 mm	160 mm
Plank thickness:	19 mm	16 mm

### Possible options:

- 1: One complete design across several planks..
- 2: Different designs on several planks (randomly) laid.
- 3: A design that repeats on a single plank.

We would be happy to review your idea and calculate a budget. The cost of a custom carving design pattern is 350 EUR. Orders will be charged for these costs. Send us the desired motif as a vector graphic. The price depends on the design and the selected material. We look forward to your ideas: [office@mafi.com](mailto:office@mafi.com)

## Custom Color (CC)

Depending on the product, knots and, if available, cracks are puttied in color and thus sealed. Here, we choose two contrary approaches according to the design. Either an attempt is made to integrate the knot/crack into the overall appearance of the plank as naturally and harmoniously as possible, or an attempt is made to highlight it in a sharply contrasting color choice.

This color choice is up to you as well and can be individually selected as part of our CC products. All we need for this is the RAL code of the desired color. We will also be glad to attempt approximations to color samples that you or your customers provide. The cost of a CC sample is 150 EUR. Orders will be charged for these costs.

**CHANGE:** The former standard colors white, silver, and sand are still available as part of the CC colors described above.

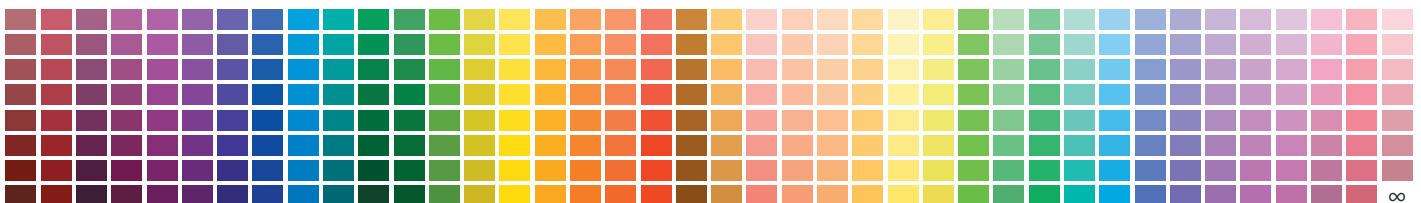

# mafi 360° – Details that matter

The secret of high-end furnishing concepts lies in the harmony of their components. A precise and reduced mix of materials is crucial. mafi therefore offers different solutions that match and coordinate with your natural wood flooring:

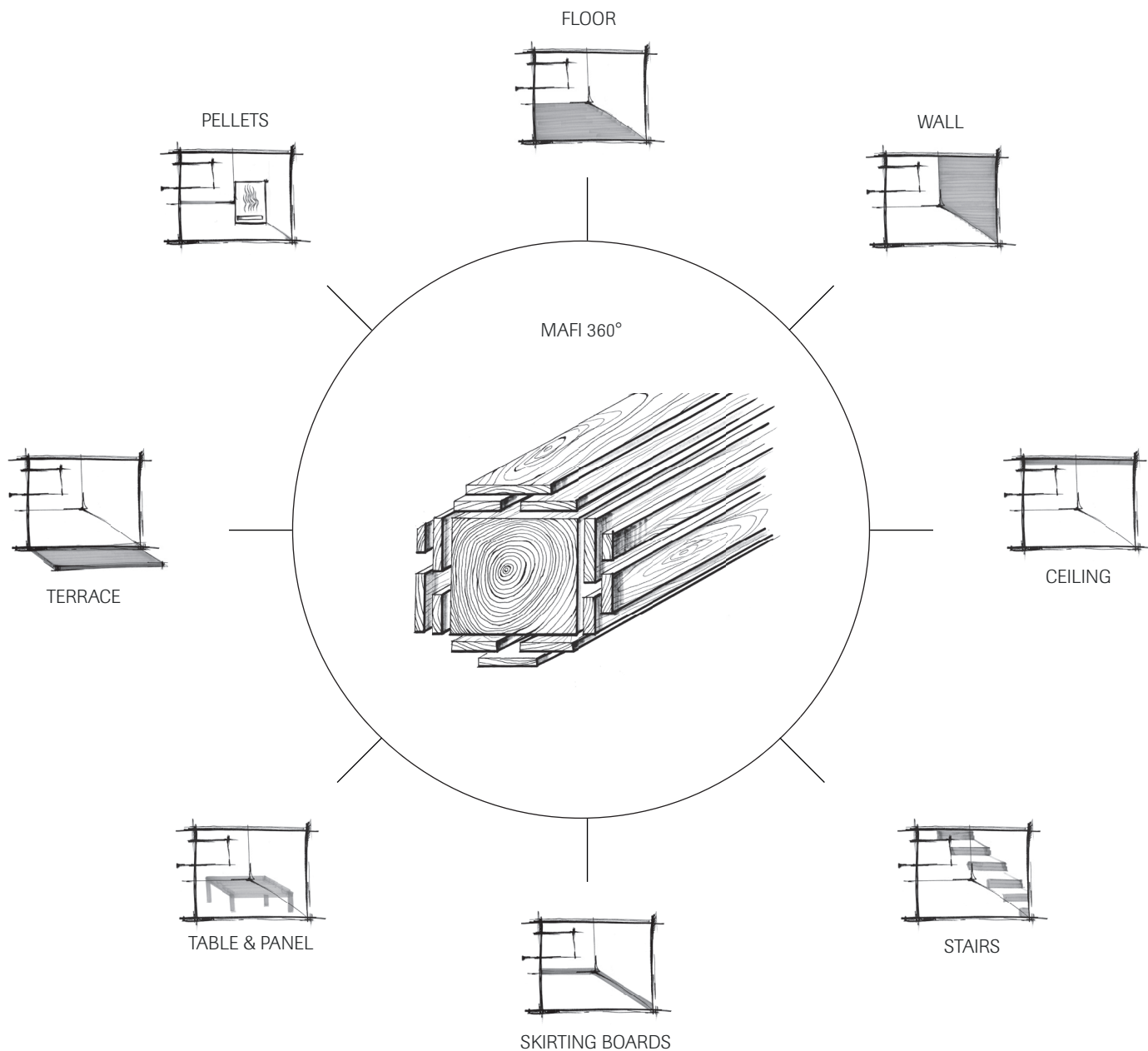

You can find an overview of all the options and many inspirational pictures on our website.

## AREAS OF APPLICATION

All mafi natural wood floors comply with the CE guidelines according to ÖNORM EN 14 342. For information on the areas of application and suitability for underfloor heating of the individual products, please refer to the respective price list sheet. ATTENTION: Only with specific expert consultation and after examination of the area of application!

**P1:** Suitable for low to medium stress areas: bedrooms, children's rooms, and living rooms etc.

**P2:** Suitable for medium to heavy duty: kitchen, dining room, etc.

**O:** Suitable for commercial areas

**Suitable for underfloor heating:** Pre-requisite: compliance with the installation and maintenance instructions!

# Installation and Care

Only mafi products may be used for the handling, cleaning and care of mafi natural wood floors. Any warranty claim is void in case of the use of third-party products, in addition no complaints will be considered. Please refer to our installation and maintenance instructions as well as the information in the mafi passport.

## Installation

Audit requirement: Prior to installation, the underfloor must be checked for its standard compliance!

mafi natural wood floors can basically be installed floating or glued partially or fully. The choice of the correct installation method can depend on local conditions.

The planks are oiled already once during production. Following installation, the entire surface must be re-treated again. Thus, a perfect surface can be handed over to our customers after the elaborate construction/reconstruction phase. With 1l of mafi wood floor oil an area of 60–90 m<sup>2</sup> can be re-oiled, depending on the absorbency of the wood.

The floor, room or product temperature should be 18–25° C. It is also necessary for sufficient airing to ensure the oil cures (oxidative drying) with oxygen. The floor must be vacuumed and free of fine dust before the oil application.

mafi wood floor oil is applied directly on the floor and polished immediately into the wood with a white pad. Edge areas should be oiled by hand. Please ensure that this is performed in the direction of the planks. Finally, the entire surface is polished with a sheep wool pad. No oil traces should remain on the surface as these will become sticky.

**CAUTION! Safety Rules:** Oil soaked cloths, fleeces, sheep's wool pads etc. must be immediately soaked in water and dried in the open air! Otherwise there is a danger of spontaneous combustion!

## The first steps after installation

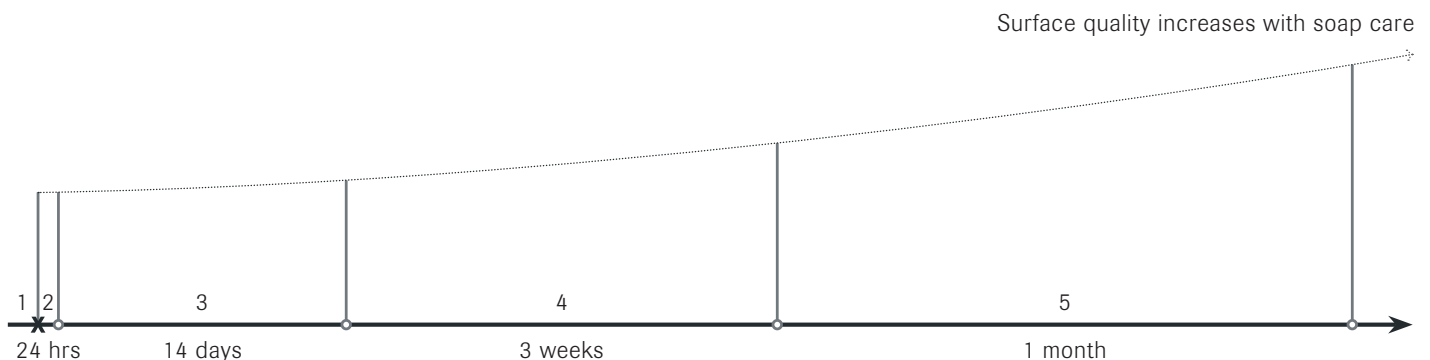

- 1 · Re-oiling on site: The floor has to be slightly re-oiled and polished after installation by professionals, in order to ensure an optimal surface.
- 2 · Allow the wood floor oil to soak in: After 24 hours, the floor can again be walked upon carefully.
- 3 · Oil penetration of the plank: During the first 14 days no liquids should come into contact with the floor.
- 4 · Care buildup: Over a period of three weeks, the floor should be wiped once a week with warm water and mafi Wood Floor Soap.
- 5 · Regular care: In an average private home, it is enough to wipe the floor once a month with warm water and mafi Wood Floor Soap – otherwise just vacuum.

We recommend using mafi maintenance oil balm instead of mafi wood floor oil to subsequently treat the following floors:

- Grey oiled floors (BKA, BKG)
- Customer-specific /custom surfaces
- Deep white natured surfaces (BTZ)
- Raw wood look (BKT)

## Finishing

After laying, apply the mafi maintenance oil balm along the length of the floorboards using a surface mop. Here, it makes sense to work on small areas. Yield per liter: approx. 20 m<sup>2</sup> (depending on the absorbency of the wood).

Let the balm absorb: The floor will be dry in approx. 1-2 hours.

Polishing the entire surface: Polish the floor with a monodisc machine and white polishing fleece.

If required, the balm may be reapplied once after drying.

## Care

Every mafi floor is unique and changes with the people who live on it. For long term value preservation, we recommend complying with six care steps. This applies: cleaning and care in one!

### BASIC EQUIPMENT

- Two buckets
- A cotton wool cleaning mop
- A mafi wood floor soap container

## Cleaning and care in one

- 1 · Fill both buckets with warm water.
- 2 · Add the suitable mafi wood floor soap into one of the two buckets (125ml soap for 5l water). This two bucket principle ensures the clean soapy water does not get mixed with the dirty water.
- 3 · Starting at the edge of the room, wipe the soapy water mixture in the direction of the door/exit using a cotton mop (mafi Vulcano floors should only be lightly wiped).
- 4 · After a short soak time, the surplus water should be wiped off with the cotton cloth mop and wrung out into the second bucket. The mafi wood floor soap dissolves the dirt from the pores and the contaminations are then removed from the wood with the second wipe of the mop.
- 5 · Thereafter, the cotton cloth mop is washed out with clean water in the second bucket.
- 6 · Repeat steps 3 - 5 for the remaining floor area.

## Technical Data mafi Natural Wood Floors

- Lindane and Pentachlorophenol: < 5 ppm
- Fire certification: CFL-s1
- Emission Category: E1
- Anti slip rate:
  - on Oak brushed: R11
  - on Domino Larch Vulcano brushed: R13

# Tiger OAK

Structure: Plank: Symmetrical 3-layer for Tiger Oak / Thin plank: Material symmetrical 3-layer for Tiger Oak

Bevel/joint: small bevel on the long side; tongue and groove on all sides for endless installation

Thermo treatment: intensive heat treatment (without chemical additives) with a continuous coloration in the cross-section of the top and back layers. Intense color differences in appearance are characteristic.

Grading: Small open cracks and unsealed spots of a few millimeters are permitted. Knots up to 25 mm diameter possible.

An extravagant and, at the same time, hard-wearing natural wood floor with the particular attraction of intense shades of colour in the wood! EVERY FLOOR IS UNIQUE!

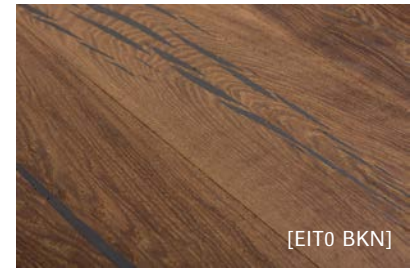

Recommended Price, excl. VAT / GST

Article Number		Dimension in mm (l x w x t)		Eur / m <sup>2</sup>
Plank (black)	EIT0 ■■■ 0000 000 □□	1800/2000/2200/2400 x 135-245 x 16 19	●	206.60
Thin-Plank (black)	ETD0 ■■■ 0000 000 10	1800/2000/2200/2400 x 135-190 x 10	●	206.60
Plank (gold)	EIT2 ■■■ 0000 000 □□	1800/2000/2200/2400 x 135-245 x 16 19	●	222.20
Thin-Plank (gold)	ETD2 ■■■ 0000 000 10	1800/2000/2200/2400 x 135-190 x 10	●	222.20
Plank (CC)	EITC ■■■ 0000 000 □□	1800/2000/2200/2400 x 135-245 x 16 19	●	236.40
Thin-Plank (CC)	ETDC ■■■ 0000 000 10	1800/2000/2200/2400 x 135-190 x 10	●	236.40

Delivery of lengths and widths is depending on production at the time, CC = Custom Colour. Indicate the colour requested in RAL-Code

Fixed dimensions in mm		Eur / m <sup>2</sup>
Lengths: 1800/2000/2400	●	8.60
Widths: 160/190/225/245	●	15.60

## LAYING FORMATS AND APPLICATIONS

Dimensions see page 9	Eur / m <sup>2</sup>	Eur / m <sup>2</sup>
Flex	● 66.00	

## SURFACES

Surfaces
----------

**B K N** brushed | natural oil

**B K W** brushed | white oil

Suitable for underfloor heating • Area of Application P1 / P2 / O • Emissions Class E1 • Fire Rating CFL-s1 • Weight per m<sup>2</sup>: 16 mm: 11,50 kg // 19 mm: 13,00 kg

With this price list, all previous editions are invalid. Error, price and technical changes reserved. Deliveries not unloaded. Delivery only in packaging units. Variations in color and structure are natural characteristics of wood. Specified measurements are top or invoice measurements.

**mafi**

# Coral OAK

Structure: Plank: Symmetrical 3-layer

Bevel/joint: small bevel on the long side; tongue and groove on all sides for endless installation

Grading: Small open cracks and unsealed spots of a few millimeters are permitted. Cracks, knotholes and large knots are emphasized with putty.

A very vivid appearance of heartwood with artistically integrated cracks. Variations in colour and sapwood at the edges possible.



Recommended Price, excl. VAT / GST

Article Number	Dimension in mm (l x w x t)	Eur / m <sup>2</sup>
Plank (black) ECC0 ■■■ 0000 190 □□	1800/2000/2200/2400 x 190 x 16 19	● 143.30
Plank (black) ECC0 ■■■ 0000 245 □□	1800/2000/2200/2400 x 245 x 16 19	● 147.20
Wide-Plank (black) CCB0 ■■■ 0000 000 19	4000/5000 x 245/260/280/300 x 19	● 195.00
Plank (gold) ECC2 ■■■ 0000 190 □□	1800/2000/2200/2400 x 190 x 16 19	● 156.20
Plank (gold) ECC2 ■■■ 0000 245 □□	1800/2000/2200/2400 x 245 x 16 19	● 162.70
Wide-Plank (gold) CCB2 ■■■ 0000 000 19	4000/5000 x 245/260/280/300 x 19	● 213.20
Plank (CC) ECCC ■■■ 0000 190 □□	1800/2000/2200/2400 x 190 x 16 19	● 167.90
Plank (CC) ECCC ■■■ 0000 245 □□	1800/2000/2200/2400 x 245 x 16 19	● 178.20
Wide-Plank (CC) CCBC ■■■ 0000 000 19	4000/5000 x 245/260/280/300 x 19	● 227.40

Delivery of lengths is depending on production at the time, CC = Custom Colour. Indicate the colour requested in RAL-Code

Fixed dimensions in mm	Eur / m <sup>2</sup>
Lengths: 1800/2000/2400	● 8.60

Delivery of lengths and widths is depending on production at the time, Delivery is made in 2 - 3 widths, depending on production at the time, CC = Custom Colour. Indicate the colour requested in RAL-Code

Fixed dimensions Wide-Plank in mm	Eur / m <sup>2</sup>
Lengths: 4000/5000	● 7.20
Widths: 245/260/280/300	● 8.60

## LAYING FORMATS AND APPLICATIONS

Dimensions see page 9	Eur / m <sup>2</sup>
Flex	● 66.00

## SURFACES

Surfaces
----------

B K N brushed | natural oil

B K W brushed | white oil

B K G brushed | grey oil

Surfaces with surcharge	Eur / m <sup>2</sup>
-------------------------	----------------------

H K N hand-planed | natural oil

H K W hand-planed | white oil

48.00

H K G hand-planed | grey oil

Suitable for underfloor heating • Area of Application P1 / P2 / O • Emissions Class E1 • Fire Rating CFL-s1 • Weight per m<sup>2</sup>: 16 mm: 10,50 kg // 19 mm: 11,50 kg

With this price list, all previous editions are invalid. Error, price and technical changes reserved. Deliveries not unloaded. Delivery only in packaging units. Variations in color and structure are natural characteristics of wood. Specified measurements are top or invoice measurements.

**mafi**

# Coral OAK Vulcano

Structure: Plank: Symmetrical 3-layer

Bevel/joint: small bevel on the long side; tongue and groove on all sides for endless installation









Thermo treatment: heat treatment Vulcano (without chemical additives) with a continuous coloration in the cross-section of the top and back layers. Color differences in appearance are characteristic.

Grading: Small open cracks and unsealed spots of a few millimeters are permitted. Cracks, knotholes and large knots are emphasized with putty.

A very vivid appearance of heartwood with artistically integrated cracks.



Recommended Price, excl. VAT / GST

Article Number	Dimension in mm (l x w x t)	Eur / m <sup>2</sup>
Plank (black) ECK0  0000 190 <input type="checkbox"/>	1800/2000/2200/2400 x 190 x 16 19	● 169.20
Plank (black) ECK0  0000 245 <input type="checkbox"/>	1800/2000/2200/2400 x 245 x 16 19	● 175.70
Wide-Plank (black) CKB0  0000 000 19	4000/5000 x 245/260/280/300 x 19	● 228.60
Plank (gold) ECK2  0000 190 <input type="checkbox"/>	1800/2000/2200/2400 x 190 x 16 19	● 180.80
Plank (gold) ECK2  0000 245 <input type="checkbox"/>	1800/2000/2200/2400 x 245 x 16 19	● 189.80
Wide-Plank (gold) CKB2  0000 000 19	4000/5000 x 245/260/280/300 x 19	● 242.80
Plank (CC) ECKC  0000 190 <input type="checkbox"/>	1800/2000/2200/2400 x 190 x 16 19	● 195.00
Plank (CC) ECKC  0000 245 <input type="checkbox"/>	1800/2000/2200/2400 x 245 x 16 19	● 205.40
Wide-Plank (CC) CKBC  0000 000 19	4000/5000 x 245/260/280/300 x 19	● 258.40

Delivery of lengths is depending on production at the time, CC = Custom Colour. Indicate the colour requested in RAL-Code

Fixed dimensions in mm	Eur / m <sup>2</sup>
Lengths: 1800/2000/2400	● 8.60

Delivery of lengths and widths is depending on production at the time, Delivery is made in 2 - 3 widths, depending on production at the time, CC = Custom Colour. Indicate the colour requested in RAL-Code

Fixed dimensions Wide-Plank in mm	Eur / m <sup>2</sup>
Lengths: 4000/5000	● 7.20
Widths: 245/260/280/300	● 8.60

## LAYING FORMATS AND APPLICATIONS

Dimensions see page 9	Eur / m <sup>2</sup>	Eur / m <sup>2</sup>
Flex	● 66.00	

## SURFACES

### Surfaces

**B K N** brushed | natural oil

**B K W** brushed | white oil

### Surfaces with surcharge

**H K N** hand-planed | natural oil

**H K W** hand-planed | white oil

48.00

Suitable for underfloor heating • Area of Application P1 / P2 / O • Emissions Class E1 • Fire Rating CFL-s1 • Weight per m<sup>2</sup>: 16 mm: 10,50 kg // 19 mm: 11,50 kg

With this price list, all previous editions are invalid. Error, price and technical changes reserved. Deliveries not unloaded. Delivery only in packaging units. Variations in color and structure are natural characteristics of wood. Specified measurements are top or invoice measurements.

**mafi**













# OAK Clear

Structure: Plank: Symmetrical 3-layer / Thin plank: Material symmetrical 3-layer  
 Bevel/joint: small bevel on the long side; tongue and groove on all sides for endless installation  
 Grading plank: The planks are free from knots and sapwood but have curled spots. Small knots and slight stress cracks are possible.  
 Grading wide-plank: The planks are free of sapwood and basically free of knots, mirrors and crown cut are possible, point knots and occasional sound knots up to 1 cm in diameter as well as slight stress cracks or end cracks are possible.  
 Hard-wearing floor planks.



Recommended Price, excl. VAT / GST

Article Number	Dimension in mm (l x w x t)	Eur / m <sup>2</sup>
Plank EAEB  0000 160 	1800/2000/2200/2400 x 160 x 16 19	169.10
Plank EAEB  0000 190 	1800/2000/2200/2400 x 190 x 16 19	177.00
Plank EAEB  0000 245 	1800/2000/2200/2400 x 245 x 16 19	192.60
Plank EAEB  0000 000 19	1800/2000/2200/2400 x 260/280/300 x 19	277.30
Thin-Plank EADD  0000 160 10	1800/2000/2200/2400 x 160 x 10	169.10
Thin-Plank EADD  0000 190 10	1800/2000/2200/2400 x 190 x 10	177.00
Wide-Plank EABD  0000 000 19	3500-5000 x 190/245/260/280/300 x 19	376.60

Delivery of lengths and widths is depending on production at the time

Fixed dimensions in mm	Eur / m <sup>2</sup>
Lengths: 1800/2000/2400	8.60
Widths: 260/280/300	8.60

Delivery of lengths and widths is depending on production at the time, Delivery is made in 2 - 3 widths, depending on production at the time

Fixed dimensions Wide-Plank in mm	Eur / m <sup>2</sup>
Lengths: 4000/5000	15.60
Widths: 190/245/260	8.60
Widths: 280/300	15.60

## LAYING FORMATS AND APPLICATIONS

Dimensions see page 9	Eur / m <sup>2</sup>	Eur / m <sup>2</sup>
Herringbone Plank 90°	14.40	Herringbone Plank 77° 18.00
Chevron Plank 45°	27.60	Chevron Plank 60° 22.80
Hexagon	28.80	Flex 66.00

## SURFACES

### Surfaces

**B K N** brushed | natural oil      **B K W** brushed | white oil      **B K G** brushed | grey oil  
**X K N** heavily brushed | natural oil      **X K W** heavily brushed | white oil

### Surfaces with surcharge

Surfaces with surcharge	Eur / m <sup>2</sup>
<b>B K M</b> brushed   1x natural oil 1x white oil	8.60
<b>B K X</b> brushed   extreme white oil	13.30
<b>B K A</b> brushed   graphite grey oil	17.20
<b>X K M</b> heavily brushed   1x natural oil 1x white oil	
<b>B K T</b> brushed   raw wood look	
<b>B T Z</b> brushed   deep white   natured	
<b>X K X</b> heavily brushed   extreme white oil	

Suitable for underfloor heating • Area of Application P1 / P2 / O • Emissions Class E1 • Fire Rating CFL-s1 • Weight per m<sup>2</sup>: 16 mm: 10,50 kg // 19 mm: 11,50 kg

With this price list, all previous editions are invalid. Error, price and technical changes reserved. Deliveries not unloaded. Delivery only in packaging units. Variations in color and structure are natural characteristics of wood. Specified measurements are top or invoice measurements.

**mafi**

# OAK Select Wide-Plank

Structure: Wide-Plank: Symmetrical 3-layer

Bevel/joint: small bevel on the long side; tongue and groove on all sides for endless installation

Grading: Planks with healthy knots are part of the appearance as are cracks up to 30 cm, knots, and knotholes sealed with golden wood putty. Repairs up to 25 mm diameter are possible.

Homogeneous knot appearance. Small open cracks and unsealed spots of a few millimeters are permitted.

Durable floors suitable for commercial properties.



Recommended Price, excl. VAT / GST

Article Number	Dimension in mm (l x w x t)		Eur / m <sup>2</sup>
EAB2 ■■■ 0000 000 19	4000/4500/5000 x 190/245/260/280/300 x 19	●	236.30

Delivery of lengths and widths is depending on production at the time

Fixed dimensions Wide-Plank in mm		Eur / m <sup>2</sup>
Lengths: 4000/5000	●	8.60
Widths: 190/245/260	●	8.60
Widths: 280/300	●	15.60

## LAYING FORMATS AND APPLICATIONS

Dimensions see page 9	Eur / m <sup>2</sup>	Eur / m <sup>2</sup>
Flex	● 66.00	

## SURFACES

Surfaces		Eur / m <sup>2</sup>
B   K   N brushed   natural oil	B   K   W brushed   white oil	
Surfaces with surcharge		Eur / m <sup>2</sup>
B   K   T brushed   raw wood look		8.60

Suitable for underfloor heating • Area of Application P1 / P2 / O • Emissions Class E1 • Fire Rating CFL-s1 • Weight per m<sup>2</sup>: 16 mm: 10,50 kg // 19 mm: 11,50 kg

With this price list, all previous editions are invalid. Error, price and technical changes reserved. Deliveries not unloaded. Delivery only in packaging units. Variations in color and structure are natural characteristics of wood. Specified measurements are top or invoice measurements.

**mafi**

# OAK Character

Structure: Plank: Symmetrical 3-layer / Thin plank: Material symmetrical 3-layer  
 Bevel/joint: small bevel on the long side; tongue and groove on all sides for endless installation  
 Grading: For the main part the planks have healthy knots. Stress cracks up to 30 cm, also torn knots and small knots are sealed with appropriate wood putty. Repairs up to 25 mm diameter are possible. Small open cracks and unsealed spots of a few millimeters are permitted.  
 Very robust floor planks, suitable for commercial use.



Recommended Price, excl. VAT / GST

Article Number	Dimension in mm (l x w x t)	Eur / m <sup>2</sup>
Plank EIEB ■■■ 0000 160 □□	1800/2000/2200/2400 x 160 x 16 19	● 150.60
Plank EIEB ■■■ 0000 190 □□	1800/2000/2200/2400 x 190 x 16 19	● 157.00
Plank EIEB ■■■ 0000 245 □□	1800/2000/2200/2400 x 245 x 16 19	● 166.10
Plank EIEB ■■■ 0000 000 19	1800/2000/2200/2400 x 260/280/300 x 19	● 212.90
Thin-Plank EIDD ■■■ 0000 160 10	1800/2000/2200/2400 x 160 x 10	● 150.60
Thin-Plank EIDD ■■■ 0000 190 10	1800/2000/2200/2400 x 190 x 10	● 157.00
Wide-Plank EIBD ■■■ 0000 000 19	4000/4500/5000 x 190/245/260/280/300 x 19	● 225.80

Delivery of lengths and widths is depending on production at the time

Fixed dimensions in mm	Eur / m <sup>2</sup>
Lengths: 1800/2000/2400	● 8.60
Widths: 260/280/300	● 8.60

Delivery of lengths and widths is depending on production at the time, Delivery is made in 2 - 3 widths, depending on production at the time

Fixed dimensions Wide-Plank in mm	Eur / m <sup>2</sup>
Lengths: 4000/5000	● 8.60
Widths: 190/245/260	● 8.60
Widths: 280/300	● 15.60

## LAYING FORMATS AND APPLICATIONS

Dimensions see page 9	Eur / m <sup>2</sup>	Eur / m <sup>2</sup>
Herringbone Plank 90°	● 14.40	Herringbone Plank 77° ● 18.00
Chevron Plank 45°	● 27.60	Chevron Plank 60° ● 22.80
Hexagon	● 28.80	Flex ● 66.00

## SURFACES

### Surfaces

B K N brushed | natural oil      B K W brushed | white oil      B K G brushed | grey oil  
 X K N heavily brushed | natural oil      X K W heavily brushed | white oil

### Surfaces with surcharge

Surfaces with surcharge	Eur / m <sup>2</sup>
B K M brushed   1x natural oil 1x white oil	8.60
B K X brushed   extreme white oil	13.30
B K A brushed   graphite grey oil	15.60
R K N rough saw texture   natural oil	17.20
X K M heavily brushed   1x natural oil 1x white oil	8.60
B K T brushed   raw wood look	13.30
B T Z brushed   deep white   natured	15.60
R K W rough saw texture   white oil	17.20
X K X heavily brushed   extreme white oil	

Suitable for underfloor heating • Area of Application P1 / P2 / O • Emissions Class E1 • Fire Rating CFL-s1 • Weight per m<sup>2</sup>: 16 mm: 10,50 kg // 19 mm: 11,50 kg

With this price list, all previous editions are invalid. Error, price and technical changes reserved. Deliveries not unloaded. Delivery only in packaging units. Variations in color and structure are natural characteristics of wood. Specified measurements are top or invoice measurements.

**mafi**

# OAK Sand

Structure: Plank: Symmetrical 3-layer / Thin plank: Material symmetrical 3-layer  
 Bevel/joint: small bevel on the long side; tongue and groove on all sides for endless installation  
 Grading: Planks with healthy knots are part of the appearance as are cracks, knots und knotholes that are accentuated by sand-coloured putty. Deviations in colour and isolated sapwood at the edges is possible. Small open cracks and unsealed spots of a few millimeters are allowed. The rather lively character harmonizes with the sand-coloured putty. This floor is suitable for heavy traffic good for commercial purposes.



[ECE5 BKN]

Recommended Price, excl. VAT / GST

Article Number	Dimension in mm (l x w x t)	Eur / m <sup>2</sup>
Plank ECE5 ■■■ 0000 190 □□	1800/2000/2200/2400 x 190 x 16 19	● 129.10
Plank ECE5 ■■■ 0000 245 □□	1800/2000/2200/2400 x 245 x 16 19	● 138.20
Plank ECE5 ■■■ 0000 000 19	1800/2000/2200/2400 x 260/280/300 x 19	● 157.70
Wide-Plank ECB5 ■■■ 0000 000 19	4000/4500/5000 x 190/245/260/280/300 x 19	● 197.60

Delivery of lengths and widths is depending on production at the time

Fixed dimensions in mm	Eur / m <sup>2</sup>
Lengths: 1800/2000/2400	● 8.60
Widths: 260/280/300	● 8.60

Delivery of lengths and widths is depending on production at the time, Delivery is made in 2 - 3 widths, depending on production at the time

Fixed dimensions Wide-Plank in mm	Eur / m <sup>2</sup>
Lengths: 4000/5000	● 8.60
Widths: 190/245/260/280/300	● 8.60

## LAYING FORMATS AND APPLICATIONS

Dimensions see page 9	Eur / m <sup>2</sup>	Eur / m <sup>2</sup>
Flex	● 66.00	

## SURFACES

Surfaces	Eur / m <sup>2</sup>
B K N brushed   natural oil	
B K W brushed   white oil	
X K N heavily brushed   natural oil	
X K W heavily brushed   white oil	
Surfaces with surcharge	Eur / m <sup>2</sup>
B T Z brushed   deep white   natured	8.60
H K W hand-planed   white oil	
H K N hand-planed   natural oil	48.00

Suitable for underfloor heating • Area of Application P1 / P2 / O • Emissions Class E1 • Fire Rating CFL-s1 • Weight per m<sup>2</sup>: 16 mm: 10,50 kg // 19 mm: 11,50 kg

With this price list, all previous editions are invalid. Error, price and technical changes reserved. Deliveries not unloaded. Delivery only in packaging units. Variations in color and structure are natural characteristics of wood. Specified measurements are top or invoice measurements.

**mafi**









# OAK Country gold

Structure: Plank: Symmetrical 3-layer / Thin plank: Material symmetrical 3-layer  
 Bevel/joint: small bevel on the long side; tongue and groove on all sides for endless installation  
 Grading: Cracks, knotholes and large knots are emphasized with black putty. Variations in colour and sapwood at the edges possible. Small open cracks and unsealed spots of a few millimeters are permitted.  
 Plank in 3-layer construction with small bevel on long side and approx. 4 mm top layer, with approx. 4 mm backing in the same wood and middle layer conifer. Tongue and groove on all sides for easy installation. Cracks, knotholes and large knots are emphasized with black putty. Variations in colour and sapwood at the edges possible. Small open cracks and unsealed spots of a few millimetres are permitted.



Very vivid character! The floor is also suitable for hard wear suited for commercial purposes.

Recommended Price, excl. VAT / GST

Article Number	Dimension in mm (l x w x t)	Eur / m <sup>2</sup>
Plank ECE2  0000 160 	1800/2000/2200/2400 x 160 x 16 19	● 121.10
Plank ECE2  0000 190 	1800/2000/2200/2400 x 190 x 16 19	● 123.60
Plank ECE2  0000 245 	1800/2000/2200/2400 x 245 x 16 19	● 129.80
Plank ECE2  0000 000 19	1800/2000/2200/2400 x 260/280/300 x 19	● 148.30
Wide-Plank ECB2  0000 000 19	4000/4500/5000 x 190/245/260/280/300 x 19	● 186.60

Delivery of lengths and widths is depending on production at the time

Fixed dimensions in mm	Eur / m <sup>2</sup>
Lengths: 1800/2000/2400	● 8.60
Widths: 260/280/300	● 8.60

Delivery of lengths and widths is depending on production at the time, Delivery is made in 2 - 3 widths, depending on production at the time

Fixed dimensions Wide-Plank in mm	Eur / m <sup>2</sup>
Lengths: 4000/5000	● 8.60
Widths: 190/245/260/280/300	● 8.60

## LAYING FORMATS AND APPLICATIONS

Dimensions see page 9	Eur / m <sup>2</sup>	Eur / m <sup>2</sup>
Flex	● 66.00	

## SURFACES

### Surfaces

- B K N** brushed | natural oil      **B K W** brushed | white oil      **X K N** heavily brushed | natural oil
- X K W** heavily brushed | white oil

### Surfaces with surcharge

<b>B T Z</b> brushed   deep white   natured	<b>B K T</b> brushed   raw wood look	8.60
<b>X K M</b> heavily brushed   1x natural oil 1x white oil		17.20
<b>H K N</b> hand-planed   natural oil	<b>H K W</b> hand-planed   white oil	48.00

Suitable for underfloor heating • Area of Application P1 / P2 / O • Emissions Class E1 • Fire Rating CFL-s1 • Weight per m<sup>2</sup>: 16 mm: 10,50 kg // 19 mm: 11,50 kg

With this price list, all previous editions are invalid. Error, price and technical changes reserved. Deliveries not unloaded. Delivery only in packaging units. Variations in color and structure are natural characteristics of wood. Specified measurements are top or invoice measurements.

# OAK Country

Structure: Plank: Symmetrical 3-layer / Thin plank: Material symmetrical 3-layer  
 Bevel/joint: small bevel on the long side; tongue and groove on all sides for endless installation  
 Grading: Cracks, knotholes and large knots are emphasized with black putty. Variations in colour and sapwood at the edges possible. Small open cracks and unsealed spots of a few millimeters are permitted.  
 Very vivid character! The floor is also suitable for hard wear suited for commercial purposes.



Recommended Price, excl. VAT / GST

Article Number		Dimension in mm (l x w x t)		Eur / m <sup>2</sup>
Plank	ECEB ■■■ 0000 160 □□	1800/2000/2200/2400 x 160 x 16 19	●	116.20
Plank	ECEB ■■■ 0000 190 □□	1800/2000/2200/2400 x 190 x 16 19	●	118.70
Plank	ECEB ■■■ 0000 245 □□	1800/2000/2200/2400 x 245 x 16 19	●	124.80
Plank	ECEB ■■■ 0000 000 19	1800/2000/2200/2400 x 260/280/300 x 19	●	143.40
Thin-Plank	ECDD ■■■ 0000 160 10	1800/2000/2200/2400 x 160 x 10	●	116.20
Thin-Plank	ECDD ■■■ 0000 190 10	1800/2000/2200/2400 x 190 x 10	●	118.70
Wide-Plank	ECBD ■■■ 0000 000 19	4000/4500/5000 x 190/245/260/280/300 x 19	●	179.30

Delivery of lengths and widths is depending on production at the time

Fixed dimensions in mm	Eur / m <sup>2</sup>
Lengths: 1800/2000/2400	● 8.60
Widths: 260/280/300	● 8.60

Delivery of lengths and widths is depending on production at the time, Delivery is made in 2 - 3 widths, depending on production at the time

Fixed dimensions Wide-Plank in mm	Eur / m <sup>2</sup>
Lengths: 4000/5000	● 8.60
Widths: 190/245/260/280/300	● 8.60

## LAYING FORMATS AND APPLICATIONS

Dimensions see page 9	Eur / m <sup>2</sup>	Eur / m <sup>2</sup>
Herringbone Plank 90°	● 14.40	Herringbone Plank 77° ● 18.00
Chevron Plank 45°	● 27.60	Chevron Plank 60° ● 22.80
Hexagon	● 28.80	Flex ● 66.00

## SURFACES

Surfaces		
B K N brushed   natural oil	B K W brushed   white oil	B K G brushed   grey oil
X K N heavily brushed   natural oil	X K W heavily brushed   white oil	

Surfaces with surcharge	Eur / m <sup>2</sup>
B T Z brushed   deep white   natured	B K X brushed   extreme white oil 8.60
B K M brushed   1x natural oil 1x white oil	B K T brushed   raw wood look
B K A brushed   graphite grey oil	13.30
X K X heavily brushed   extreme white oil	X K M heavily brushed   1x natural oil 1x white oil 17.20
R K N rough saw texture   natural oil	R K W rough saw texture   white oil 15.60
H K N hand-planed   natural oil	H K W hand-planed   white oil 48.00

Suitable for underfloor heating • Area of Application P1 / P2 / O • Emissions Class E1 • Fire Rating CFL-s1 • Weight per m<sup>2</sup>: 16 mm: 10,50 kg // 19 mm: 11,50 kg

With this price list, all previous editions are invalid. Error, price and technical changes reserved. Deliveries not unloaded. Delivery only in packaging units. Variations in color and structure are natural characteristics of wood. Specified measurements are top or invoice measurements.



**mafi**

# OAK Molto

Structure: Plank: Symmetrical 3-layer / Thin plank: Material symmetrical 3-layer  
 Bevel/joint: small bevel on the long side; tongue and groove on all sides for endless installation  
 Grading: End cracks, stress cracks and knotholes up to 30 mm are permitted and sealed with appropriate putty. Variations in color and sapwood are characteristic. Small open cracks and unsealed spots of a few millimeters are permitted.  
 The floor captivates with its generous shades of color and an extravagant surface characteristic.



Recommended Price, excl. VAT / GST

Article Number	Dimension in mm (l x w x t)	Eur / m <sup>2</sup>
Plank EIEM  0000 000 	1800/2000/2400 x 100-190 x 16 19	● 108.50
Thin-Plank EIDM  0000 000 10	1800/2000/2400 x 110-185 x 10	● 108.50

Delivery of lengths and widths is depending on production at the time, Due to the properties of the raw material NO specific widths can be ordered

Fixed dimensions in mm	Eur / m <sup>2</sup>
Lengths: 1800/2000/2400	● 8.60

## LAYING FORMATS AND APPLICATIONS

Dimensions see page 9	Eur / m <sup>2</sup>	Eur / m <sup>2</sup>
Flex	● 66.00	

## SURFACES

Surfaces
----------

 brushed | natural oil

 brushed | white oil

Suitable for underfloor heating • Area of Application P1 / P2 / O • Emissions Class E1 • Fire Rating CFL-s1 • Weight per m<sup>2</sup>: 16 mm: 10,50 kg // 19 mm: 11,50 kg

With this price list, all previous editions are invalid. Error, price and technical changes reserved. Deliveries not unloaded. Delivery only in packaging units. Variations in color and structure are natural characteristics of wood. Specified measurements are top or invoice measurements.

**mafi**

# OAK Vulcano Medium

Structure: Plank: Symmetrical 3-layer

Bevel/joint: small bevel on the long side; tongue and groove on all sides for endless installation

Thermo treatment: heat treatment Vulcano Medium (without chemical additives) with a continuous coloration in the cross-section of the top and back layers. Color differences in appearance are characteristic.

Grading: For the main part the planks have healthy knots, isolated repairs up to 25 mm diameter and tension cracks up to max. 30 cm are possible. Small open cracks and unsealed spots of a few millimeters are permitted.

Variations in colour emphasize the beautiful appearance of this superior floor. The Medium Vulcano treatment creates a wide mix from light-brown to brown planks.

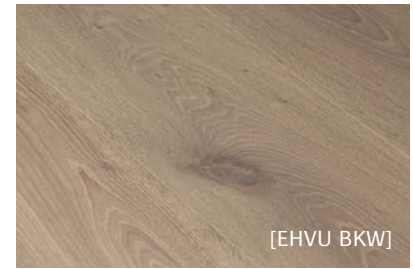

Recommended Price, excl. VAT / GST

Article Number	Dimension in mm (l x w x t)	Eur / m <sup>2</sup>
Plank EHVU  0000 160 <input type="checkbox"/>	1800/2000/2200/2400 x 160 x 16 19	● 179.50
Plank EHVU  0000 190 <input type="checkbox"/>	1800/2000/2200/2400 x 190 x 16 19	● 188.60
Plank EHVU  0000 245 <input type="checkbox"/>	1800/2000/2200/2400 x 245 x 16 19	● 196.40
Plank EHVU  0000 000 19	1800/2000/2200/2400 x 260/280/300 x 19	● 275.20
Wide-Plank EHVb  0000 000 19	4000/4500/5000 x 190/245/260/280/300 x 19	● 313.90

Delivery of lengths and widths is depending on production at the time

Fixed dimensions in mm	Eur / m <sup>2</sup>
Lengths: 1800/2000/2400	● 8.60
Widths: 260/280/300	● 8.60

Delivery of lengths and widths is depending on production at the time, Delivery is made in 2 - 3 widths, depending on production at the time

Fixed dimensions Wide-Plank in mm	Eur / m <sup>2</sup>
Lengths: 4000/5000	● 8.60
Widths: 190/245/260	● 8.60
Widths: 280/300	● 15.60

## LAYING FORMATS AND APPLICATIONS

Dimensions see page 9	Eur / m <sup>2</sup>	Eur / m <sup>2</sup>
Herringbone Plank 90°	● 14.40	Herringbone Plank 77° ● 18.00
Chevron Plank 45°	● 27.60	Chevron Plank 60° ● 22.80
Hexagon	● 28.80	Flex ● 66.00

## SURFACES

Surfaces	Eur / m <sup>2</sup>
<b>B K N</b> brushed   natural oil	
<b>B K W</b> brushed   white oil	
<b>X K N</b> heavily brushed   natural oil	
<b>X K W</b> heavily brushed   white oil	
Surfaces with surcharge	Eur / m <sup>2</sup>
<b>R K N</b> rough saw texture   natural oil	
<b>R K W</b> rough saw texture   white oil	15.60

Suitable for underfloor heating • Area of Application P1 / P2 / O • Emissions Class E1 • Fire Rating CFL-s1 • Weight per m<sup>2</sup>: 16 mm: 10,50 kg // 19 mm: 11,50 kg

With this price list, all previous editions are invalid. Error, price and technical changes reserved. Deliveries not unloaded. Delivery only in packaging units. Variations in color and structure are natural characteristics of wood. Specified measurements are top or invoice measurements.

**mafi**



# OAK Country Vulcano Medium

Structure: Plank: Symmetrical 3-layer

Bevel/joint: small bevel on the long side; tongue and groove on all sides for endless installation

Thermo treatment: heat treatment Vulcano Medium (without chemical additives) with a continuous coloration in the cross-section of the top and back layers. Color differences in appearance are characteristic.

Grading: Cracks, knotholes and large knots are emphasized with black putty. Variations in colour and sapwood at the edges possible. Small open cracks and unsealed spots of a few millimeters are permitted.

Intense color play between light-brown and brown.

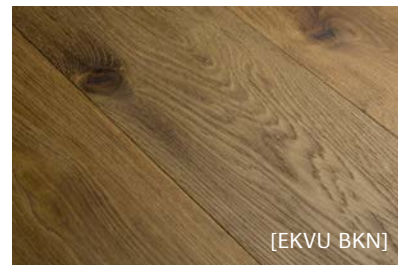

Recommended Price, excl. VAT / GST

Article Number	Dimension in mm (l x w x t)	Eur / m <sup>2</sup>
Plank EKVU ■■■ 0000 160 □□	1800/2000/2200/2400 x 160 x 16 19	● 152.40
Plank EKVU ■■■ 0000 190 □□	1800/2000/2200/2400 x 190 x 16 19	● 158.90
Plank EKVU ■■■ 0000 245 □□	1800/2000/2200/2400 x 245 x 16 19	● 166.70
Plank EKVU ■■■ 0000 000 19	1800/2000/2200/2400 x 260/280/300 x 19	● 189.80
Wide-Plank EKVB ■■■ 0000 000 19	4000/4500/5000 x 190/245/260/280/300 x 19	● 229.90

Delivery of lengths and widths is depending on production at the time

Fixed dimensions in mm	Eur / m <sup>2</sup>
Lengths: 1800/2000/2400	● 8.60
Widths: 260/280/300	● 8.60

Delivery of lengths and widths is depending on production at the time, Delivery is made in 2 - 3 widths, depending on production at the time

Fixed dimensions Wide-Plank in mm	Eur / m <sup>2</sup>
Lengths: 4000/5000	● 8.60
Widths: 190/245/260/280/300	● 8.60

## LAYING FORMATS AND APPLICATIONS

Dimensions see page 9	Eur / m <sup>2</sup>
Flex	● 66.00

## SURFACES

### Surfaces

**B K N** brushed | natural oil      **B K W** brushed | white oil      **X K N** heavily brushed | natural oil

**X K W** heavily brushed | white oil

### Surfaces with surcharge

**R K N** rough saw texture | natural oil      **R K W** rough saw texture | white oil      15.60

Suitable for underfloor heating • Area of Application P1 / P2 / O • Emissions Class E1 • Fire Rating CFL-s1 • Weight per m<sup>2</sup>: 16 mm: 10,50 kg // 19 mm: 11,50 kg

With this price list, all previous editions are invalid. Error, price and technical changes reserved. Deliveries not unloaded. Delivery only in packaging units. Variations in color and structure are natural characteristics of wood. Specified measurements are top or invoice measurements.

**mafi**

# OAK Vulcano

Structure: Plank: Symmetrical 3-layer

Bevel/joint: small bevel on the long side; tongue and groove on all sides for endless installation

Thermo treatment: heat treatment Vulcano (without chemical additives) with a continuous coloration in the cross-section of the top and back layers. Color differences in appearance are characteristic.

Grading: For the main part the planks have healthy knots, isolated repairs up to 25 mm diameter and tension cracks up to max. 30 cm are possible. Small open cracks and unsealed spots of a few millimeters are permitted.

Variations in colour emphasize the beautiful appearance of this superior, mid- to dark-brown floor.

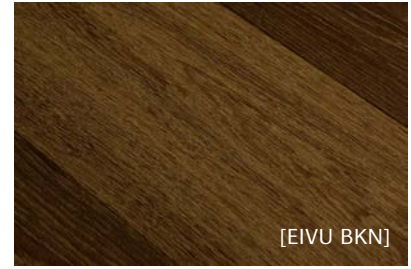

Recommended Price, excl. VAT / GST

Article Number	Dimension in mm (l x w x t)	Eur / m <sup>2</sup>
Plank EIVU ■■■ 0000 160 □□	1800/2000/2200/2400 x 160 x 16 19	● 179.50
Plank EIVU ■■■ 0000 190 □□	1800/2000/2200/2400 x 190 x 16 19	● 188.60
Plank EIVU ■■■ 0000 245 □□	1800/2000/2200/2400 x 245 x 16 19	● 196.40
Plank EIVU ■■■ 0000 000 19	1800/2000/2200/2400 x 260/280/300 x 19	● 275.20
Wide-Plank EIVB ■■■ 0000 000 19	4000/4500/5000 x 190/245/260/280/300 x 19	● 313.90

Delivery of lengths and widths is depending on production at the time

Fixed dimensions in mm	Eur / m <sup>2</sup>
Lengths: 1800/2000/2400	● 8.60
Widths: 260/280/300	● 8.60

Delivery of lengths and widths is depending on production at the time, Delivery is made in 2 - 3 widths, depending on production at the time

Fixed dimensions Wide-Plank in mm	Eur / m <sup>2</sup>
Lengths: 4000/5000	● 8.60
Widths: 190/245/260	● 8.60
Widths: 280/300	● 15.60

## LAYING FORMATS AND APPLICATIONS

Dimensions see page 9	Eur / m <sup>2</sup>	Eur / m <sup>2</sup>
Herringbone Plank 90°	● 14.40	● Herringbone Plank 77° 18.00
Chevron Plank 45°	● 27.60	● Chevron Plank 60° 22.80
Hexagon	● 28.80	● Flex 66.00

## SURFACES

Surfaces	Eur / m <sup>2</sup>
<b>B K N</b> brushed   natural oil	
<b>B K W</b> brushed   white oil	
<b>X K N</b> heavily brushed   natural oil	
<b>X K W</b> heavily brushed   white oil	
Surfaces with surcharge	Eur / m <sup>2</sup>
<b>R K N</b> rough saw texture   natural oil	
<b>R K W</b> rough saw texture   white oil	15.60

Suitable for underfloor heating • Area of Application P1 / P2 / O • Emissions Class E1 • Fire Rating CFL-s1 • Weight per m<sup>2</sup>: 16 mm: 10,50 kg // 19 mm: 11,50 kg

With this price list, all previous editions are invalid. Error, price and technical changes reserved. Deliveries not unloaded. Delivery only in packaging units. Variations in color and structure are natural characteristics of wood. Specified measurements are top or invoice measurements.

**mafi**

# OAK Country Vulcano

Structure: Plank: Symmetrical 3-layer

Bevel/joint: small bevel on the long side; tongue and groove on all sides for endless installation

Thermo treatment: heat treatment Vulcano (without chemical additives) with a continuous coloration in the cross-section of the top and back layers. Color differences in appearance are characteristic.

Grading: Cracks, knotholes and large knots are emphasized with black putty. Variations in colour and sapwood at the edges possible. Small open cracks and unsealed spots of a few millimeters are permitted.

Chocolate brown floor with very vivid character! Very robust floor planks, suitable for commercial use.



[ECVU BKN]

Recommended Price, excl. VAT / GST

Article Number	Dimension in mm (l x w x t)	Eur / m <sup>2</sup>
Plank ECVU ■■■ 0000 160 □□	1800/2000/2200/2400 x 160 x 16 19	● 152.40
Plank ECVU ■■■ 0000 190 □□	1800/2000/2200/2400 x 190 x 16 19	● 158.90
Plank ECVU ■■■ 0000 245 □□	1800/2000/2200/2400 x 245 x 16 19	● 166.70
Plank ECVU ■■■ 0000 000 19	1800/2000/2200/2400 x 260/280/300 x 19	● 189.80
Wide-Plank ECVB ■■■ 0000 000 19	4000/4500/5000 x 190/245/260/280/300 x 19	● 229.90

Delivery of lengths and widths is depending on production at the time

Fixed dimensions in mm	Eur / m <sup>2</sup>
Lengths: 1800/2000/2400	● 8.60
Widths: 260/280/300	● 8.60

Delivery of lengths and widths is depending on production at the time, Delivery is made in 2 - 3 widths, depending on production at the time

Fixed dimensions Wide-Plank in mm	Eur / m <sup>2</sup>
Lengths: 4000/5000	● 8.60
Widths: 190/245/260/280/300	● 8.60

## LAYING FORMATS AND APPLICATIONS

Dimensions see page 9	Eur / m <sup>2</sup>
Flex	● 66.00

## SURFACES

### Surfaces

**B K N** brushed | natural oil      **B K W** brushed | white oil      **X K N** heavily brushed | natural oil  
**X K W** heavily brushed | white oil

Surfaces with surcharge	Eur / m <sup>2</sup>
<b>R K N</b> rough saw texture   natural oil <b>R K W</b> rough saw texture   white oil	15.60
<b>H K N</b> hand-planed   natural oil <b>H K W</b> hand-planed   white oil	48.00

Suitable for underfloor heating • Area of Application P1 / P2 / O • Emissions Class E1 • Fire Rating CFL-s1 • Weight per m<sup>2</sup>: 16 mm: 10,50 kg // 19 mm: 11,50 kg

With this price list, all previous editions are invalid. Error, price and technical changes reserved. Deliveries not unloaded. Delivery only in packaging units. Variations in color and structure are natural characteristics of wood. Specified measurements are top or invoice measurements.

**mafi**

# OAK Molto Vulcano

Structure: Plank: Symmetrical 3-layer

Bevel/joint: small bevel on the long side; tongue and groove on all sides for endless installation

Thermo treatment: heat treatment Vulcano (without chemical additives) with a continuous coloration in the cross-section of the top and back layers. Color differences in appearance are characteristic.

Grading: End cracks, stress cracks and knotholes up to 30mm are permitted. Variations in color and sapwood are characteristic. Small open cracks and unsealed spots of a few millimeters are permitted.

The floor captivates with its generous shades of color and an extravagant surface characteristic.

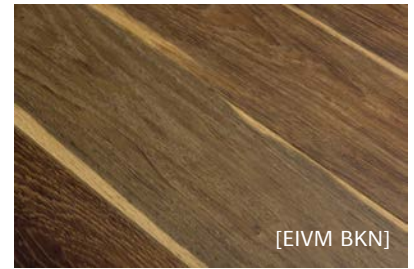

Recommended Price, excl. VAT / GST

Article Number	Dimension in mm (l x w x t)		Eur / m <sup>2</sup>
EIVM <span style="display: inline-block; width: 10px; height: 10px; background-color: #808080; border: 1px solid #ccc; margin-right: 5px;"></span> <span style="display: inline-block; width: 10px; height: 10px; background-color: #808080; border: 1px solid #ccc; margin-right: 5px;"></span> <span style="display: inline-block; width: 10px; height: 10px; background-color: #808080; border: 1px solid #ccc; margin-right: 5px;"></span> 0000 000 <span style="display: inline-block; width: 10px; height: 10px; border: 1px solid #ccc; margin-right: 5px;"></span> <span style="display: inline-block; width: 10px; height: 10px; border: 1px solid #ccc;"></span>	1800/2000/2400 x 100-190 x 16 19	<span style="color: green;">●</span>	134.90

Delivery of lengths and widths is depending on production at the time. Due to the properties of the raw material NO specific widths can be ordered

Fixed dimensions in mm		Eur / m <sup>2</sup>
Lengths: 1800/2000/2400	<span style="color: red;">●</span>	8.60

## LAYING FORMATS AND APPLICATIONS

Dimensions see page 9	Eur / m <sup>2</sup>	Eur / m <sup>2</sup>
Flex	<span style="color: red;">●</span> 66.00	

## SURFACES

Surfaces
----------

B K N brushed | natural oil

B K W brushed | white oil

Suitable for underfloor heating • Area of Application P1 / P2 / O • Emissions Class E1 • Fire Rating CFL-s1 • Weight per m<sup>2</sup>: 16 mm: 10,50 kg // 19 mm: 11,50 kg

With this price list, all previous editions are invalid. Error, price and technical changes reserved. Deliveries not unloaded. Delivery only in packaging units. Variations in color and structure are natural characteristics of wood. Specified measurements are top or invoice measurements.

**mafi**

# Nero OAK Vulcano

Structure: Plank: Symmetrical 3-layer

Bevel/joint: small bevel on the long side; tongue and groove on all sides for endless installation

Thermo treatment: heat treatment Nero Vulcano (without chemical additives) with a continuous coloration in the cross-section of the top and back layers. Color differences in appearance are characteristic.

Grading: For the main part the planks have healthy knots, isolated repairs up to 30 mm diameter are possible. Small open cracks and unsealed spots of a few millimeters are permitted.

A superior, uniform black floor. Variations in the colour of the individual planks lightens up the surface appearance.

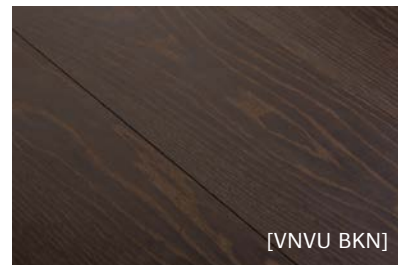

Recommended Price, excl. VAT / GST

Article Number	Dimension in mm (l x w x t)		Eur / m <sup>2</sup>
VNVU ■■■ 0000 155 □□	1800/2000/2200/2400 x 155 x 16 19	●	179.50
VNVU ■■■ 0000 185 □□	1800/2000/2200/2400 x 185 x 16 19	●	188.60
VNVU ■■■ 0000 240 □□	1800/2000/2200/2400 x 240 x 16 19	●	201.50

Delivery of lengths is depending on production at the time

Fixed dimensions in mm	Eur / m <sup>2</sup>
Lengths: 1800/2000/2400	● 8.60

## LAYING FORMATS AND APPLICATIONS

Dimensions see page 9	Eur / m <sup>2</sup>	Eur / m <sup>2</sup>
Flex	● 66.00	

## SURFACES

Surfaces		Eur / m <sup>2</sup>
B K N brushed   natural oil	B K W brushed   white oil	
Surfaces with surcharge		Eur / m <sup>2</sup>
R K N rough saw texture   natural oil	R K W rough saw texture   white oil	15.60

Suitable for underfloor heating • Area of Application P1 / P2 • Emissions Class E1 • Fire Rating CFL-s1 • Weight per m<sup>2</sup>: 16 mm: 10,50 kg // 19 mm: 11,50 kg

With this price list, all previous editions are invalid. Error, price and technical changes reserved. Deliveries not unloaded. Delivery only in packaging units. Variations in color and structure are natural characteristics of wood. Specified measurements are top or invoice measurements.

**mafi**

# OAK Country Riva Mezzo

Structure: Plank: Symmetrical 3-layer for Riva

Bevel/joint: large bevel on the long side; tongue and groove on all sides for endless installation





Grading: The surface of the top layer is treated to give a roughened appearance. Cracks, knotholes and large knots are emphasized with black putty. Variations in colour and sapwood at the edges possible. Small open cracks and unsealed spots of a few millimeters are permitted.

Very vivid character! All Riva Mezzo products are brushed and have a large bevel alongside.



[R002 BKW]

Recommended Price, excl. VAT / GST

Article Number	Dimension in mm (l x w x t)	Eur / m <sup>2</sup>
Plank R002  2400 245 	2400 x 245 x 16 19	 150.80
Wide-Plank R02B  0000 000 19	4000/5000 x 190/245/260/280/300 x 19	 218.80

Delivery of lengths and widths is depending on production at the time, Delivery is made in 2 - 3 widths, depending on production at the time

Fixed dimensions Wide-Plank in mm	Eur / m <sup>2</sup>
Widths: 190/245/260/280/300	 8.60

## LAYING FORMATS AND APPLICATIONS

Dimensions see page 9	Eur / m <sup>2</sup>	Eur / m <sup>2</sup>
Flex	 66.00	

## SURFACES

Surfaces
----------

 brushed | natural oil

 brushed | white oil

Suitable for underfloor heating • Area of Application P1 / P2 / O • Emissions Class E1 • Fire Rating CFL-s1 • Weight per m<sup>2</sup>: 16 mm: 10,50 kg // 19 mm: 11,50 kg

With this price list, all previous editions are invalid. Error, price and technical changes reserved. Deliveries not unloaded. Delivery only in packaging units. Variations in color and structure are natural characteristics of wood. Specified measurements are top or invoice measurements.

**mafi**

# OAK Country Vulcano Riva Mezzo

Structure: Plank: Symmetrical 3-layer for Riva

Bevel/joint: large bevel on the long side; tongue and groove on all sides for endless installation

Thermo treatment: heat treatment Vulcano (without chemical additives) with a continuous coloration in the cross-section of the top and back layers. Color differences in appearance are characteristic.

Grading: The surface of the top layer is treated to give a roughened appearance. Cracks, knotholes and large knots are emphasized with black putty. Variations in colour and sapwood at the edges possible. Small open cracks and unsealed spots of a few millimeters are permitted. Chocolate brown floor with very vivid character! Very robust floor planks, suitable for commercial use. All Riva Mezzo products are brushed and have a large bevel alongside.

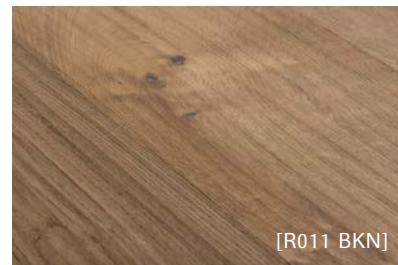

Recommended Price, excl. VAT / GST

Article Number		Dimension in mm (l x w x t)		Eur / m <sup>2</sup>
Plank	R011	■ ■ ■ 2400 245 □ □	2400 x 245 x 16 19	● 191.20
Wide-Plank	R11B	■ ■ ■ 0000 000 19	4000/5000 x 190/245/260/280/300 x 19	● 266.20

Delivery of lengths and widths is depending on production at the time, Delivery is made in 2 - 3 widths, depending on production at the time

Fixed dimensions Wide-Plank in mm	Eur / m <sup>2</sup>
-----------------------------------	----------------------

Widths: 190/245/260/280/300	● 8.60
-----------------------------	--------

## LAYING FORMATS AND APPLICATIONS

Dimensions see page 9	Eur / m <sup>2</sup>	Eur / m <sup>2</sup>
-----------------------	----------------------	----------------------

Flex	●	66.00
------	---	-------

## SURFACES

Surfaces
----------

**B K N** brushed | natural oil

**B K W** brushed | white oil

Suitable for underfloor heating • Area of Application P1 / P2 / O • Emissions Class E1 • Fire Rating CFL-s1 • Weight per m<sup>2</sup>: 16 mm: 10,50 kg // 19 mm: 11,50 kg

With this price list, all previous editions are invalid. Error, price and technical changes reserved. Deliveries not unloaded. Delivery only in packaging units. Variations in color and structure are natural characteristics of wood. Specified measurements are top or invoice measurements.

**mafi**

# OAK Country Riva Mare

Structure: Plank: Symmetrical 3-layer for Riva





Bevel/joint: large bevel on the long side; tongue and groove on all sides for endless installation

Grading: The surface of the top layer is treated to give a slightly roughened appearance. Cracks, knotholes and large knots are emphasized with black putty. Variations in colour and sapwood at the edges possible. Small open cracks and unsealed spots of a few millimeters are permitted.

Very vivid character!



Recommended Price, excl. VAT / GST

Article Number	Dimension in mm (l x w x t)	Eur / m <sup>2</sup>
Plank R402  2400 245 	2400 x 245 x 16 19	 150.80
Wide-Plank R42B  0000 000 19	4000/5000 x 190/245/260/280/300 x 19	 218.80

Delivery of lengths and widths is depending on production at the time, Delivery is made in 2 - 3 widths, depending on production at the time

Fixed dimensions Wide-Plank in mm	Eur / m <sup>2</sup>
Widths: 190/245/260/280/300	 8.60

## LAYING FORMATS AND APPLICATIONS

Dimensions see page 9	Eur / m <sup>2</sup>	Eur / m <sup>2</sup>
Flex	 66.00	

## SURFACES

Surfaces
----------

 brushed | natural oil

 brushed | white oil

Suitable for underfloor heating • Area of Application P1 / P2 / O • Emissions Class E1 • Fire Rating CFL-s1 • Weight per m<sup>2</sup>: 16 mm: 10,50 kg // 19 mm: 11,50 kg

With this price list, all previous editions are invalid. Error, price and technical changes reserved. Deliveries not unloaded. Delivery only in packaging units. Variations in color and structure are natural characteristics of wood. Specified measurements are top or invoice measurements.

**mafi**



# OAK Country Vulcano Riva Mare

Structure: Plank: Symmetrical 3-layer for Riva



Bevel/joint: large bevel on the long side; tongue and groove on all sides for endless installation

Thermo treatment: heat treatment Vulcano (without chemical additives) with a continuous coloration in the cross-section of the top and back layers. Color differences in appearance are characteristic.

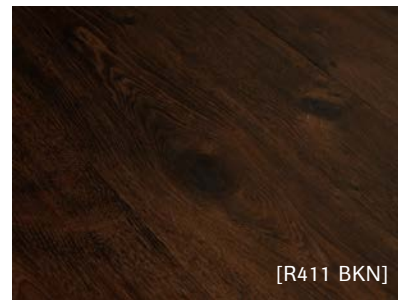
Grading: he surface of the top layer is treated to give a roughened appearance. Cracks, knotholes and large knots are emphasized with black putty. Variations in colour and sapwood at the edges possible. Small open cracks and unsealed spots of a few millimeters are permitted. Chocolate brown floor with very vivid character! Very robust floor planks, suitable for commercial use.



Recommended Price, excl. VAT / GST

Article Number	Dimension in mm (l x w x t)	Eur / m <sup>2</sup>
Plank R411  2400 245 	2400 x 245 x 16 19	● 191.20
Wide-Plank R41B  0000 000 19	4000/5000 x 190/245/260/280/300 x 19	● 266.20

Delivery of lengths and widths is depending on production at the time, Delivery is made in 2 - 3 widths, depending on production at the time

Fixed dimensions Wide-Plank in mm	Eur / m <sup>2</sup>
-----------------------------------	----------------------

Widths: 190/245/260/280/300	● 8.60
-----------------------------	--------

## LAYING FORMATS AND APPLICATIONS

Dimensions see page 9	Eur / m <sup>2</sup>	Eur / m <sup>2</sup>
Flex	● 66.00	

## SURFACES

Surfaces
----------

**B K N** brushed | natural oil

**B K W** brushed | white oil

Suitable for underfloor heating • Area of Application P1 / P2 / O • Emissions Class E1 • Fire Rating CFL-s1 • Weight per m<sup>2</sup>: 16 mm: 10,50 kg // 19 mm: 11,50 kg

With this price list, all previous editions are invalid. Error, price and technical changes reserved. Deliveries not unloaded. Delivery only in packaging units. Variations in color and structure are natural characteristics of wood. Specified measurements are top or invoice measurements.

**mafi**

# LARCH

Structure: Plank: Symmetrical 3-layer

Bevel/joint: small bevel on the long side; tongue and groove on all sides for endless installation

Grading: End cracks, stress cracks and knotholes up to 30 mm are permitted and sealed with appropriate putty. Variations in color and sapwood are characteristic. Small open cracks and unsealed spots of a few millimeters are permitted.

Beautiful, vivid surface appearance, full of character. A hard-wearing conifer floor.



[LAEB BLW]

Recommended Price, excl. VAT / GST

Article Number		Dimension in mm (l x w x t)		Eur / m <sup>2</sup>
Plank	LAEB ■■■ 2480 190 □□	2480 x 190 x 16 19	●	112.30
Plank	LAEB ■■■ 2480 220 □□	2480 x 220 x 16 19	●	118.90
Plank	LAEB ■■■ 4000 190 □□	4000 x 190 x 16 19	●	126.50
Plank	LAEB ■■■ 4000 220 □□	4000 x 220 x 16 19	●	131.80
Plank	LAEB ■■■ 5000 190 □□	5000 x 190 x 16 19	●	126.50
Plank	LAEB ■■■ 5000 220 □□	5000 x 220 x 16 19	●	131.80
Wide-Plank	LABD ■■■ 0000 000 19	4000/5000 x 190/220/260/280/300 x 19	●	153.70

Delivery of lengths and widths is depending on production at the time

Fixed dimensions Wide-Plank in mm	Eur / m <sup>2</sup>
Lengths: 4000/5000	● 8.60
Widths: 240/260	● 8.60
Widths: 280/300	● 15.60

## LAYING FORMATS AND APPLICATIONS

Dimensions see page 9	Eur / m <sup>2</sup>	Eur / m <sup>2</sup>
Flex	● 66.00	

## SURFACES

Surfaces	
B K N brushed   natural oil	B K W brushed   white oil
Surfaces with surcharge	
B L N brushed   lye treated   natural oil	B L W brushed   lye treated   white oil
B T Z brushed   deep white   natured	
R K N rough saw texture   natural oil	

Suitable for underfloor heating • Area of Application P1 / P2 / O • Emissions Class E1 • Fire Rating CFL-s1 • Weight per m<sup>2</sup>: 16 mm: 7,56 kg // 19 mm: 8,90 kg

With this price list, all previous editions are invalid. Error, price and technical changes reserved. Deliveries not unloaded. Delivery only in packaging units. Variations in color and structure are natural characteristics of wood. Specified measurements are top or invoice measurements.

**mafi**

# LARCH Country

Structure: Plank: Symmetrical 3-layer

Bevel/joint: small bevel on the long side; tongue and groove on all sides for endless installation

Grading: Heartwood with proportionate cracks is blended. Knotholes and cracks as well as pitch pockets are filled with black putty. Some sapwood is possible. Not suitable for underfloor heating. Small open cracks and unsealed spots of a few millimeters are permitted.

Very vivid surface appearance! A hard-wearing conifer floor.



Recommended Price, excl. VAT / GST

Article Number	Dimension in mm (l x w x t)	Eur / m <sup>2</sup>
Plank LCEB ■■■ 2480 000 □□	2480 x 190 - 220 x 16 19	● 97.70
Wide-Plank LCBD ■■■ 0000 000 19	4000/5000 x 190/220/260/280/300 x 19	● 122.80

Delivery of lengths and widths is depending on production at the time, Delivery is made in 2 - 3 widths, depending on production at the time, Due to the properties of the raw material NO specific widths can be ordered

Fixed dimensions Wide-Plank in mm	Eur / m <sup>2</sup>
Lengths: 4000/5000	● 8.60

## LAYING FORMATS AND APPLICATIONS

Dimensions see page 9	Eur / m <sup>2</sup>	Eur / m <sup>2</sup>
Flex	● 66.00	

## SURFACES

### Surfaces

**B K N** brushed | natural oil      **B K W** brushed | white oil

### Surfaces with surcharge

**B L N** brushed | lye treated | natural oil      **B L W** brushed | lye treated | white oil      8.60

**B T Z** brushed | deep white | natured

Not Suitable for underfloor heating • Area of Application P1 / P2 / O • Emissions Class E1 • Fire Rating CFL-s1 • Weight per m<sup>2</sup>: 16 mm: 7,56 kg // 19 mm: 8,90 kg

With this price list, all previous editions are invalid. Error, price and technical changes reserved. Deliveries not unloaded. Delivery only in packaging units. Variations in color and structure are natural characteristics of wood. Specified measurements are top or invoice measurements.



# LARCH Vulcano

Structure: Plank: Symmetrical 3-layer

Bevel/joint: small bevel on the long side; tongue and groove on all sides for endless installation





Thermo treatment: heat treatment Vulcano (without chemical additives) with a continuous coloration in the cross-section of the top and back layers. Color differences in appearance are characteristic.

Grading: Knots up to 50 mm diameter and splay knots (30 x 60 mm) are possible, also max. 2 false knots per metre of plank length. Max. 4 pitch pockets per plank are permitted, also cracks up to 50 cm. Some sapwood is possible. Small open cracks and unsealed spots of a few millimeters are permitted.

The beautiful shades of colour and the varying structures result in the unique antique character of this floor.



Recommended Price, excl. VAT / GST

Article Number	Dimension in mm (l x w x t)	Eur / m <sup>2</sup>
Plank LAVU  0000 000 	1980/2480 x 190/220 x 16 19	 138.20
Wide-Plank LAVB  0000 000 19	4000/5000 x 190/220/260/280/300 x 19	 167.90

## Fixed dimensions in mm

Fixed dimensions in mm	Eur / m <sup>2</sup>
Lengths: 1980/2480	 8.60
Widths: 190/220	 8.60

Delivery of lengths and widths is depending on production at the time

## Fixed dimensions Wide-Plank in mm

Fixed dimensions Wide-Plank in mm	Eur / m <sup>2</sup>
Lengths: 4000/5000	 8.60
Widths: 190/220/240/260	 8.60
Widths: 280/300	 15.60

## LAYING FORMATS AND APPLICATIONS

Dimensions see page 9	Eur / m <sup>2</sup>	Eur / m <sup>2</sup>
Flex	 66.00	

## SURFACES

### Surfaces

**B K N** brushed | natural oil

**B K W** brushed | white oil

Suitable for underfloor heating • Area of Application P1 / P2 • Emissions Class E1 • Fire Rating CFL-s1 • Weight per m<sup>2</sup>: 16 mm: 7,56 kg // 19 mm: 8,90 kg

With this price list, all previous editions are invalid. Error, price and technical changes reserved. Deliveries not unloaded. Delivery only in packaging units. Variations in color and structure are natural characteristics of wood. Specified measurements are top or invoice measurements.

**mafi**

# DOUGLAS FIR

Structure: Plank: Symmetrical 3-layer

Bevel/joint: small bevel on the long side; tongue and groove on all sides for endless installation

Grading: Typical are few bony, well-embedded knots up to 60 mm diameter and pronounced formation of the annual rings. Cotter as well as isolated knotholes, splints and cracks are possible and are closed with appropriate wood putty. Small open cracks and unsealed spots of a few millimeters are permitted.

Impressive boards with a subtle appearance interspersed with a clear surface structure.



[DOEB BTZ]

Recommended Price, excl. VAT / GST

Article Number	Dimension in mm (l x w x t)	Eur / m <sup>2</sup>
Plank DOEB ■■■ 0000 240 16	1980/2480 x 240 x 16	120.10
Plank DOEB ■■■ 0000 000 19	1980/2480 x 190/220/240/260/280/300 x 19	120.10
Wide-Plank DOBD ■■■ 0000 000 19	4000/5000 x 190/220/240/260/280/300 x 19	133.10

## Fixed dimensions in mm

Lengths: 1980/2480	8.60
Widths: 190/220/240/260	8.60

Delivery of lengths and widths is depending on production at the time

## Fixed dimensions Wide-Plank in mm

Lengths: 4000/5000	8.60
Widths: 190/220/240/260	8.60
Widths: 280/300	15.60

## LAYING FORMATS AND APPLICATIONS

Dimensions see page 9	Eur / m <sup>2</sup>	Eur / m <sup>2</sup>
Flex	66.00	

## SURFACES

### Surfaces

B K N brushed | natural oil

### Surfaces with surcharge

B L W brushed | lye treated | white oil      B T Z brushed | deep white | natured      8.60

Suitable for underfloor heating • Area of Application P1 / P2 / O • Emissions Class E1 • Fire Rating CFL-s1 • Weight per m<sup>2</sup>: 16 mm: 7,56 kg // 19 mm: 8,90 kg

With this price list, all previous editions are invalid. Error, price and technical changes reserved. Deliveries not unloaded. Delivery only in packaging units. Variations in color and structure are natural characteristics of wood. Specified measurements are top or invoice measurements.

**mafi**

# FIR

Structure: Plank: Symmetrical 3-layer

Bevel/joint: small bevel on the long side; tongue and groove on all sides for endless installation

Grading: This particularly robust raw material originates from native mountain forests (Austria), from trees felled in the winter months. Typical are bony, well-embedded knots up to 60 mm diameter and pronounced formation of the annual rings. Isolated knotholes up to 30 mm diameter are sealed with appropriate wood putty. Stress cracks up to 50 cm are possible. Small open cracks and unsealed spots of a few millimeters are permitted.

This floor is ideal for rustic-style rooms and also for contemporary architecture.



Recommended Price, excl. VAT / GST

Article Number	Dimension in mm (l x w x t)	Eur / m <sup>2</sup>
Plank TAEB ■■■ 0000 000 16	1980/2480 x 220/240 x 16	94.30
Plank TAEB ■■■ 0000 000 19	1980/2480 x 220/240/260/280/300 x 19	94.30
Wide-Plank TABD ■■■ 0000 000 19	4000/5000 x 220/240/260/280/300 x 19	107.30

Delivery of lengths and widths is depending on production at the time

Fixed dimensions Wide-Plank in mm	Eur / m <sup>2</sup>
Lengths: 1980/2480	8.60
Lengths: 4000/5000	8.60
Widths: 245/260/280/300	8.60

## LAYING FORMATS AND APPLICATIONS

Dimensions see page 9	Eur / m <sup>2</sup>	Eur / m <sup>2</sup>
Flex	66.00	

## SURFACES

### Surfaces

**B K N** brushed | natural oil

**B K W** brushed | white oil

**B K G** brushed | grey oil

### Surfaces with surcharge

**B L W** brushed | lye treated | white oil

**B T Z** brushed | deep white | natured

8.60

**B A Z** brushed | silver | natured

Suitable for underfloor heating • Area of Application P1 • Emissions Class E1 • Fire Rating CFL-s1 • Weight per m<sup>2</sup>: 16 mm: 7,14 kg // 19 mm: 8,40 kg

With this price list, all previous editions are invalid. Error, price and technical changes reserved. Deliveries not unloaded. Delivery only in packaging units. Variations in color and structure are natural characteristics of wood. Specified measurements are top or invoice measurements.

**mafi**

# SWISS STONE PINE

Structure: Plank: Symmetrical 3-layer

Bevel/joint: small bevel on the long side; tongue and groove on all sides for endless installation

Grading: Typical surface with large knots up to 100 mm diameter and sapwood (around 1/3 of the plank). Isolated sealed cracks up to max. 1/3 of plank length are possible; stress cracks in the knots and small cracks of up to max. 25 mm diameter are also closed with appropriate wood putty. Small open cracks and unsealed spots of a few millimeters are permitted.

This floor is appreciated particularly by connoisseurs and lovers of Swiss Pine for its fragrance.

Scientific studies have proved its positive effect on sleep behaviour. (Source: Institut für

Nichtinvasive Diagnostik, Austria) The floor is therefore highly recommended for installation in

bedrooms and relaxation rooms. A further advantage of Swiss Pine is its function as natural protection against moths!



Recommended Price, excl. VAT / GST

Article Number	Dimension in mm (l x w x t)		Eur / m <sup>2</sup>
ZIEB ■■■ 0000 000 □□	2000-5000 x 120-240 x 16 19	●	165.20
ZIEB ■■■ 0000 000 19	2000-5000 x 120-300 x 19	●	165.20

Delivery of lengths and widths is depending on production at the time. Due to the properties of the raw material NO specific lengths and widths can be ordered

## LAYING FORMATS AND APPLICATIONS

Dimensions see page 9	Eur / m <sup>2</sup>	Eur / m <sup>2</sup>
Flex	● 66.00	

## SURFACES

### Surfaces

**B K N** brushed | natural oil

**B K W** brushed | white oil

Suitable for underfloor heating • Area of Application P1 • Emissions Class E1 • Fire Rating CFL-s1 • Weight per m<sup>2</sup>: 16 mm: 7,08 kg // 19 mm: 8,30 kg

With this price list, all previous editions are invalid. Error, price and technical changes reserved. Deliveries not unloaded. Delivery only in packaging units. Variations in color and structure are natural characteristics of wood. Specified measurements are top or invoice measurements.

**mafi**

# SPRUCE

Structure: Plank: Symmetrical 3-layer

Bevel/joint: small bevel on the long side; tongue and groove on all sides for endless installation

Grading: Isolated fillings and small pitch pockets are possible. Healthy knots (max. 35 mm diameter) and splay knots (max. 20 x 60 mm), are permitted. Knotholes of up to 20 mm diameter are closed with appropriate wood putty. Sealed cracks up to max. 1/3 of plank length are possible. Small open cracks and unsealed spots of a few millimeters are permitted.

The surface is close-grained and its appearance very beautiful and uniform.



Recommended Price, excl. VAT / GST

Article Number	Dimension in mm (l x w x t)		Eur / m <sup>2</sup>
FIEB ■■■ 2480 190 □□	2480 x 190 x 16 19	●	72.40
FIEB ■■■ 3980 190 □□	3980 x 190 x 16 19	●	85.30

## LAYING FORMATS AND APPLICATIONS

Dimensions see page 9	Eur / m <sup>2</sup>	Eur / m <sup>2</sup>
Flex	● 66.00	

## SURFACES

### Surfaces

**B K N** brushed | natural oil

**B K W** brushed | white oil

### Surfaces with surcharge

**R K N** rough saw texture | natural oil

**R K W** rough saw texture | white oil

Eur / m<sup>2</sup>

15.60

Suitable for underfloor heating • Area of Application P1 • Emissions Class E1 • Fire Rating CFL-s1 • Weight per m<sup>2</sup>: 16 mm: 7,14 kg // 19 mm: 8,40 kg

With this price list, all previous editions are invalid. Error, price and technical changes reserved. Deliveries not unloaded. Delivery only in packaging units. Variations in color and structure are natural characteristics of wood. Specified measurements are top or invoice measurements.

**mafi**



# UNI ASH

Structure: Plank: Symmetrical 3-layer

Bevel/joint: small bevel on the long side; tongue and groove on all sides for endless installation

Grading: The planks are mostly sound knots. There are no color contrasts present in the ash core. Tension cracks up to 30 cm as well as branch cracks and small knots are filled with suitable wood putty. Putty fillings up to 25 mm circumference are possible. Small open cracks and unsealed spots of a few millimeters are permitted.

Modern and hard-wearing natural wood floor!



Recommended Price, excl. VAT / GST

Article Number	Dimension in mm (l x w x t)		Eur / m <sup>2</sup>
WEEB ■■■ 0000 155 □□	1800/2000/2400 x 155 x 16 19	●	139.40
WEEB ■■■ 0000 185 □□	1800/2000/2400 x 185 x 16 19	●	142.20
WEEB ■■■ 0000 240 □□	1800/2000/2400 x 240 x 16 19	●	144.80

Delivery of lengths is depending on production at the time

Fixed dimensions in mm	Eur / m <sup>2</sup>
------------------------	----------------------

Lengths: 1800/2000/2400	●	8.60
-------------------------	---	------

## LAYING FORMATS AND APPLICATIONS

Dimensions see page 9	Eur / m <sup>2</sup>		Eur / m <sup>2</sup>
Herringbone Plank 90°	● 14.40	Herringbone Plank 77°	● 18.00
Chevron Plank 45°	● 27.60	Chevron Plank 60°	● 22.80
Flex	● 66.00		

## SURFACES

Surfaces
----------

B K N brushed | natural oil

B K W brushed | white oil

B K G brushed | grey oil

B T Z brushed | deep white | natured

Suitable for underfloor heating • Area of Application P1 / P2 / O • Emissions Class E1 • Fire Rating CFL-s1 • Weight per m<sup>2</sup>: 16 mm: 10,00 kg // 19 mm: 11,00 kg

With this price list, all previous editions are invalid. Error, price and technical changes reserved. Deliveries not unloaded. Delivery only in packaging units. Variations in color and structure are natural characteristics of wood. Specified measurements are top or invoice measurements.

**mafi**

# COR ASH

Structure: Plank: Symmetrical 3-layer

Bevel/joint: small bevel on the long side; tongue and groove on all sides for endless installation

Grading: The planks are mostly sound knots. The typical ash wood core and flame-like grain are part of the appearance. Tension cracks up to 30 cm as well as branch cracks and small knots are filled with suitable wood putty. Putty fillings up to 25 mm circumference are possible. Small open cracks and unsealed spots of a few millimeters are permitted.

Modern and hard-wearing natural wood floor!



Recommended Price, excl. VAT / GST

Article Number	Dimension in mm (l x w x t)		Eur / m <sup>2</sup>
CEEB ■■■ 0000 155 □□	1800/2000/2400 x 155 x 16 19	●	131.60
CEEB ■■■ 0000 185 □□	1800/2000/2400 x 185 x 16 19	●	133.00
CEEB ■■■ 0000 240 □□	1800/2000/2400 x 240 x 16 19	●	136.90

Delivery of lengths is depending on production at the time

Fixed dimensions in mm	Eur / m <sup>2</sup>
------------------------	----------------------

Lengths: 1800/2000/2400	●	8.60
-------------------------	---	------

## LAYING FORMATS AND APPLICATIONS

Dimensions see page 9	Eur / m <sup>2</sup>	Eur / m <sup>2</sup>
-----------------------	----------------------	----------------------

Flex	●	66.00
------	---	-------

## SURFACES

Surfaces
----------

**B K N** brushed | natural oil

**B K W** brushed | white oil

**B K A** brushed | graphite grey oil

**B T Z** brushed | deep white | natured

Suitable for underfloor heating • Area of Application P1 / P2 / O • Emissions Class E1 • Fire Rating CFL-s1 • Weight per m<sup>2</sup>: 16 mm: 10,00 kg // 19 mm: 11,00 kg

With this price list, all previous editions are invalid. Error, price and technical changes reserved. Deliveries not unloaded. Delivery only in packaging units. Variations in color and structure are natural characteristics of wood. Specified measurements are top or invoice measurements.

**mafi**

# ASH Vulcano Medium

Structure: Plank: Symmetrical 3-layer

Bevel/joint: small bevel on the long side; tongue and groove on all sides for endless installation

Thermo treatment: heat treatment Vulcano Medium (without chemical additives) with a continuous coloration in the cross-section of the top and back layers. Color differences in appearance are characteristic.

Grading: The planks are knot-free and isolated tension cracks are possible. Small open cracks and unsealed spots of a few millimeters are permitted.

A warm, golden and very superior shade of colour.



Recommended Price, excl. VAT / GST

Article Number	Dimension in mm (l x w x t)		Eur / m <sup>2</sup>
EMVU ■■■ 0000 155 □□	1800/2000/2400 x 155 x 16 19	●	142.80
EMVU ■■■ 0000 185 □□	1800/2000/2400 x 185 x 16 19	●	145.40
EMVU ■■■ 0000 240 □□	1800/2000/2400 x 240 x 16 19	●	148.10

Delivery of lengths is depending on production at the time

Fixed dimensions in mm	Eur / m <sup>2</sup>
Lengths: 1800/2000/2400	● 8.60

## LAYING FORMATS AND APPLICATIONS

Dimensions see page 9	Eur / m <sup>2</sup>		Eur / m <sup>2</sup>
Herringbone Plank 90°	● 14.40	Herringbone Plank 77°	● 18.00
Chevron Plank 45°	● 27.60	Chevron Plank 60°	● 22.80
Flex	● 66.00		

## SURFACES

Surfaces
<b>B K N</b> brushed   natural oil
<b>B K W</b> brushed   white oil

Suitable for underfloor heating • Area of Application P1 / P2 / O • Emissions Class E1 • Fire Rating CFL-s1 • Weight per m<sup>2</sup>: 16 mm: 10,00 kg // 19 mm: 11,00 kg

With this price list, all previous editions are invalid. Error, price and technical changes reserved. Deliveries not unloaded. Delivery only in packaging units. Variations in color and structure are natural characteristics of wood. Specified measurements are top or invoice measurements.

**mafi**

# WALNUT USA

Structure: Plank: Symmetrical 3-layer

Bevel/joint: small bevel on the long side; tongue and groove on all sides for endless installation

Grading: Sapwood possible, healthy knots, also repairs up to max. 15 mm diameter and spot fillings are permitted. Small open cracks and unsealed spots of a few millimeters are permitted.

Dark walnut colour with slightly darker shades possible.

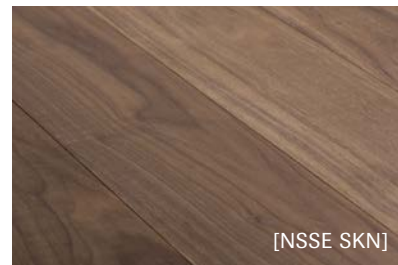

Recommended Price, excl. VAT / GST

Article Number	Dimension in mm (l x w x t)		Eur / m <sup>2</sup>
NSSE ■■■ 0000 000 □□	1800-3500 x 135-240 x 16 19	●	264.80

Delivery of lengths and widths is depending on production at the time, Due to the properties of the raw material NO specific lengths and widths can be ordered

## LAYING FORMATS AND APPLICATIONS

Dimensions see page 9		Eur / m <sup>2</sup>	Eur / m <sup>2</sup>
Flex	●	66.00	

## SURFACES

### Surfaces

S K N sanded | natural oil

S K W sanded | white oil

Suitable for underfloor heating • Area of Application P1 / P2 / O • Emissions Class E1 • Fire Rating CFL-s1 • Weight per m<sup>2</sup>: 16 mm: 10,00 kg // 19 mm: 11,00 kg

With this price list, all previous editions are invalid. Error, price and technical changes reserved. Deliveries not unloaded. Delivery only in packaging units. Variations in color and structure are natural characteristics of wood. Specified measurements are top or invoice measurements.

**mafi**

# BEECH Vulcano Fresco

Structure: Plank: Symmetrical 3-layer for Fresco

Bevel/joint: small bevel on the long side bevelled (2,5mm); tongue and groove on all sides for endless installation

Thermo treatment: heat treatment Vulcano (without chemical additives) with a continuous coloration in the cross-section of the top and back layers. Color differences in appearance are characteristic.

This floor is particularly suitable for zones often walked on barefoot, as its 3-D structures have a massaging effect on the soles of the foot. With their decorative character, mafi Fresco planks are also ideal design elements for walls and ceilings.

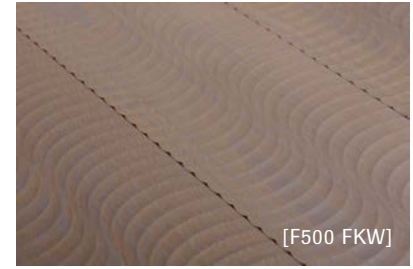

Recommended Price, excl. VAT / GST

Article Number		Dimension in mm (l x w x t)		Eur / m <sup>2</sup>
Duna	F500	<b>F K N</b>	2400 185 <input type="checkbox"/> <input type="checkbox"/>	2400 x 185 x 16 19 ● 229.90
Duna	F500	<b>F K W</b>	2400 185 <input type="checkbox"/> <input type="checkbox"/>	2400 x 185 x 16 19 ● 250.60
Rombo	F501	<b>F K N</b>	2400 185 <input type="checkbox"/> <input type="checkbox"/>	2400 x 185 x 16 19 ● 229.90
Rombo	F501	<b>F K W</b>	2400 185 <input type="checkbox"/> <input type="checkbox"/>	2400 x 185 x 16 19 ● 250.60
Punto	F502	<b>F K N</b>	2400 185 <input type="checkbox"/> <input type="checkbox"/>	2400 x 185 x 16 19 ● 229.90
Punto	F502	<b>F K W</b>	2400 185 <input type="checkbox"/> <input type="checkbox"/>	2400 x 185 x 16 19 ● 250.60

Floors of the Fresco collection with white oiled surfaces are white oiled by hand

## LAYING FORMATS AND APPLICATIONS

Dimensions see page 9	Eur / m <sup>2</sup>	Eur / m <sup>2</sup>
Flex	● 66.00	

## SURFACES

### Surfaces

**F K N** milled | natural oil

**F K W** milled | white oil

Suitable for underfloor heating • Area of Application P1 • Emissions Class E1 • Fire Rating CFL-s1 • Weight per m<sup>2</sup>: 16 mm: 10,00 kg // 19 mm: 11,00 kg

With this price list, all previous editions are invalid. Error, price and technical changes reserved. Deliveries not unloaded. Delivery only in packaging units. Variations in color and structure are natural characteristics of wood. Specified measurements are top or invoice measurements.

**mafi**

## UNI ASH Fresco Sabbia

Structure: Plank: Symmetrical 3-layer for Fresco

Bevel/joint: small bevel on the long side; tongue and groove on all sides for endless installation

Grading: The planks are mostly sound knots. There are no color contrasts present in the ash core. Tension cracks up to 30 cm as well as branch cracks and small knots are filled with suitable wood putty. Putty fillings up to 25 mm circumference are possible. Small open cracks and unsealed spots of a few millimeters are permitted.

This floor is particularly suitable for zones often walked on barefoot, as its 3-D structures have a massaging effect on the soles of the foot. With their decorative character, mafi Fresco planks are also ideal design elements for walls and ceilings.



Recommended Price, excl. VAT / GST

Article Number		Dimension in mm (l x w x t)		Eur / m <sup>2</sup>
F206	■ ■ ■ 2400 155 □ □	2400 x 155 x 16 19	●	223.40
F206	■ ■ ■ 2400 185 □ □	2400 x 185 x 16 19	●	226.00
F206	■ ■ ■ 2400 240 □ □	2400 x 240 x 16 19	●	228.70

### LAYING FORMATS AND APPLICATIONS

Dimensions see page 9		Eur / m <sup>2</sup>	Eur / m <sup>2</sup>
Flex	●	66.00	

### SURFACES

#### Surfaces

F K N milled | natural oil

F K W milled | white oil

F K G milled | grey oil

F T Z milled | deep white | natured

Suitable for underfloor heating • Area of Application P1 / P2 / O • Emissions Class E1 • Fire Rating CFL-s1 • Weight per m<sup>2</sup>: 16 mm: 10,00 kg // 19 mm: 11,00 kg

With this price list, all previous editions are invalid. Error, price and technical changes reserved. Deliveries not unloaded. Delivery only in packaging units. Variations in color and structure are natural characteristics of wood. Specified measurements are top or invoice measurements.

**mafi**

# ASH Vulcano Medium Fresco Sabbia

Structure: Plank: Symmetrical 3-layer

Bevel/joint: small bevel on the long side; tongue and groove on all sides for endless installation

Thermo treatment: heat treatment Vulcano Medium (without chemical additives) with a continuous coloration in the cross-section of the top and back layers. Color differences in appearance are characteristic.

Grading: The planks are knot-free and isolated tension cracks are possible. Small open cracks and unsealed spots of a few millimeters are permitted.

This floor is particularly suitable for zones often walked on barefoot, as its 3-D structures have a massaging effect on the soles of the foot. With their decorative character, mafi Fresco planks are also ideal design elements for walls and ceilings.

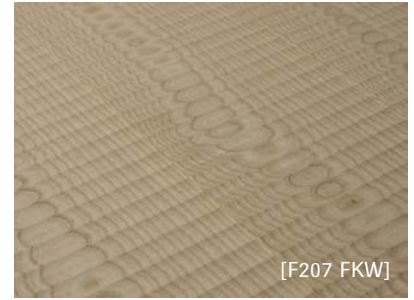

Recommended Price, excl. VAT / GST

Article Number	Dimension in mm (l x w x t)	Eur / m <sup>2</sup>
F207 <b>F K N</b> 2400 155 <input type="checkbox"/> <input type="checkbox"/>	2400 x 155 x 16 19	● 209.00
F207 <b>F K N</b> 2400 185 <input type="checkbox"/> <input type="checkbox"/>	2400 x 185 x 16 19	● 211.60
F207 <b>F K N</b> 2400 240 <input type="checkbox"/> <input type="checkbox"/>	2400 x 240 x 16 19	● 214.20

## LAYING FORMATS AND APPLICATIONS

Dimensions see page 9	Eur / m <sup>2</sup>	Eur / m <sup>2</sup>
Flex	● 66.00	

## SURFACES

Surfaces
<b>F K N</b> milled   natural oil
<b>F K W</b> milled   white oil

Suitable for underfloor heating • Area of Application P1 / P2 / O • Emissions Class E1 • Fire Rating CFL-s1 • Weight per m<sup>2</sup>: 16 mm: 10,00 kg // 19 mm: 11,00 kg

With this price list, all previous editions are invalid. Error, price and technical changes reserved. Deliveries not unloaded. Delivery only in packaging units. Variations in color and structure are natural characteristics of wood. Specified measurements are top or invoice measurements.

**mafi**

# Carving Grunge I

Structure: Plank: Symmetrical 3-layer

Bevel/joint: small bevel on the long side; tongue and groove on all sides for endless installation



Thermo treatment: heat treatment Vulcano (without chemical additives) with a continuous coloration in the cross-section of the top and back layers. Color differences in appearance are characteristic.

Grading: Oak plank (1/2 OAK Country Vulcano, 1/2 OAK Country). Cracks, branch knots and splay knots are highlighted with black putty. Colour variations and some sapwood are possible. Small open cracks and unsealed spots in the millimetre range are allowed. The graphic design is laid out across approx. 15 m<sup>2</sup>. In order to get the most natural image, it should be taken into

consideration that any repeat planks should not be laid out close to each other. Small open cracks and unsealed spots of a few millimeters are permitted.



Recommended Price, excl. VAT / GST

Article Number	Dimension in mm (l x w x t)		Eur / m <sup>2</sup>
C001  0000 155 	1800/2000/2200/2400 x 155 x 16 19		286.80

Delivery of lengths is depending on production at the time

Fixed dimensions in mm	Eur / m <sup>2</sup>
------------------------	----------------------

Lengths: 1800/2000/2400		8.60
-------------------------	---	------

## LAYING FORMATS AND APPLICATIONS

Dimensions see page 9	Eur / m <sup>2</sup>	Eur / m <sup>2</sup>
-----------------------	----------------------	----------------------

Flex		66.00
------	---	-------

## SURFACES

Surfaces
----------

 brushed | white oil

Suitable for underfloor heating • Area of Application P1 / P2 / O • Emissions Class E1 • Fire Rating CFL-s1 • Weight per m<sup>2</sup>: 16 mm: 10,50 kg // 19 mm: 11,50 kg

With this price list, all previous editions are invalid. Error, price and technical changes reserved. Deliveries not unloaded. Delivery only in packaging units. Variations in color and structure are natural characteristics of wood. Specified measurements are top or invoice measurements.

**mafi**



# BEECH Carving Club I

Structure: Plank: Symmetrical 3-layer

Bevel/joint: small bevel on the long side; tongue and groove on all sides for endless installation

Thermo treatment: heat treatment Vulcano (without chemical additives) with a continuous coloration in the cross-section of the top and back layers. Color differences in appearance are characteristic.

Grading: The graphic design runs along the plank and is repeated several times lengthwise. Small open cracks and unsealed spots of a few millimeters are permitted.

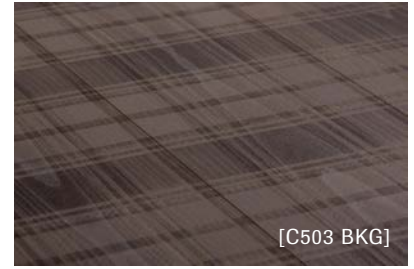

Carving is an extraordinary symbiosis between the natural structure of wood and a variety on graphic design. The innovative Carving technology enables us to engrave classic,

retro modern and contemporary designs into naturally oiled wood surfaces. Directness, clarity and structure - Carving Club I projects these values with its honest yet sophisticated design. Its subtle charm ensures a highly recognizable value, but without intruding. Through its striking design Carving Club I is especially suited for boutiques and showrooms. It is also ideal for health & spa areas due to its non-slip surface.



[C503 BKG]

Recommended Price, excl. VAT / GST

Article Number	Dimension in mm (l x w x t)	Eur / m <sup>2</sup>
C503 	2400 x 185 x 16 19	 299.80

## LAYING FORMATS AND APPLICATIONS

Dimensions see page 9	Eur / m <sup>2</sup>	Eur / m <sup>2</sup>
Flex	 66.00	

## SURFACES

Surfaces
 brushed   natural oil  brushed   white oil  brushed   grey oil

Suitable for underfloor heating • Area of Application P1 / P2 / O • Emissions Class E1 • Fire Rating CFL-s1 • Weight per m<sup>2</sup>: 16 mm: 10 kg // 19 mm: 11,00 kg

With this price list, all previous editions are invalid. Error, price and technical changes reserved. Deliveries not unloaded. Delivery only in packaging units. Variations in color and structure are natural characteristics of wood. Specified measurements are top or invoice measurements.

# OAK Clear Carving Chevron I

Structure: Plank: Symmetrical 3-layer

Bevel/joint: small bevel on the long side; tongue and groove on all sides for endless installation

Grading: The planks are free from knots and sapwood but have curled spots. Small knots and slight stress cracks are possible. Small open cracks and unsealed spots of a few millimeters are permitted.

Carving is an extraordinary symbiosis between the natural structure of wood and a variety on graphic design. The innovative Carving technology enables us to engrave classic, retro modern and contemporary designs into naturally oiled wood surfaces. Directness, clarity and structure - Carving Club I projects these values with its honest yet sophisticated design. Its subtle charm ensures a highly recognizable value, but without intruding. Through its striking design Carving Club I is especially suited for boutiques and showrooms. It is also ideal for health & spa areas due to its non-slip surface.



Recommended Price, excl. VAT / GST

Article Number	Dimension in mm (l x w x t)	Eur / m <sup>2</sup>
C019 <span style="display: inline-block; width: 10px; height: 10px; background-color: #808080; margin-right: 5px;"></span> <span style="display: inline-block; width: 10px; height: 10px; background-color: #808080; margin-right: 5px;"></span> <span style="display: inline-block; width: 10px; height: 10px; background-color: #808080; margin-right: 5px;"></span> 2400 240 <span style="display: inline-block; width: 10px; height: 10px; border: 1px solid black; margin-right: 5px;"></span> <span style="display: inline-block; width: 10px; height: 10px; border: 1px solid black;"></span>	2400 x 240 x 16 19	● 214.80

## LAYING FORMATS AND APPLICATIONS

Dimensions see page 9	Eur / m <sup>2</sup>	Eur / m <sup>2</sup>
Flex	● 66.00	

## SURFACES

### Surfaces

**B K N** brushed | natural oil

**B K W** brushed | white oil

**B K G** brushed | grey oil

Suitable for underfloor heating • Area of Application P1 / P2 / O • Emissions Class E1 • Fire Rating CFL-s1 • Weight per m<sup>2</sup>: 16 mm: 10,50 kg // 19 mm: 11,50 kg

With this price list, all previous editions are invalid. Error, price and technical changes reserved. Deliveries not unloaded. Delivery only in packaging units. Variations in color and structure are natural characteristics of wood. Specified measurements are top or invoice measurements.

**mafi**

# OAK Vulcano Medium Carving Chevron I

Structure: Plank: Symmetrical 3-layer

Bevel/joint: small bevel on the long side; tongue and groove on all sides for endless installation

Thermo treatment: heat treatment Vulcano Medium (without chemical additives) with a continuous coloration in the cross-section of the top and back layers. Color differences in appearance are characteristic.

Grading: For the main part the planks have healthy knots, isolated repairs up to 25 mm diameter and tension cracks up to max. 30 cm are possible. Small open cracks and unsealed spots of a few millimeters are permitted.

Carving is an extraordinary symbiosis between the natural structure of wood and a variety on graphic design. The innovative Carving technology enables us to engrave classic, retro modern and contemporary designs into naturally oiled wood surfaces. Directness, clarity and structure - Carving Club I projects these values with its honest yet sophisticated design. Its subtle charm ensures a highly recognizable value, but without intruding. Through its striking design Carving Club I is especially suited for boutiques and showrooms. It is also ideal for health & spa areas due to its non-slip surface.

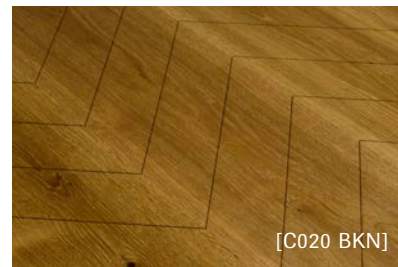

Recommended Price, excl. VAT / GST

Article Number	Dimension in mm (l x w x t)	Eur / m <sup>2</sup>
C020 <input checked="" type="checkbox"/> <input type="checkbox"/> <input type="checkbox"/> 2400 240 <input type="checkbox"/> <input type="checkbox"/>	2400 x 240 x 16 19	● 224.80

## LAYING FORMATS AND APPLICATIONS

Dimensions see page 9	Eur / m <sup>2</sup>	Eur / m <sup>2</sup>
Flex	● 66.00	

## SURFACES

Surfaces
<input checked="" type="checkbox"/> <input type="checkbox"/> <input type="checkbox"/> brushed   natural oil
<input type="checkbox"/> <input type="checkbox"/> <input type="checkbox"/> brushed   white oil

Suitable for underfloor heating • Area of Application P1 / P2 / O • Emissions Class E1 • Fire Rating CFL-s1 • Weight per m<sup>2</sup>: 16 mm: 10,50 kg // 19 mm: 11,50 kg

With this price list, all previous editions are invalid. Error, price and technical changes reserved. Deliveries not unloaded. Delivery only in packaging units. Variations in color and structure are natural characteristics of wood. Specified measurements are top or invoice measurements.

**mafi**

# OAK Vulcano Carving Chevron I

Structure: Plank: Symmetrical 3-layer

Bevel/joint: small bevel on the long side; tongue and groove on all sides for endless installation

Thermo treatment: heat treatment Vulcano (without chemical additives) with a continuous coloration in the cross-section of the top and back layers. Color differences in appearance are characteristic.

Grading: For the main part the planks have healthy knots, isolated repairs up to 25 mm diameter and tension cracks up to max. 30 cm are possible. Small open cracks and unsealed spots of a few millimeters are permitted.

Carving is an extraordinary symbiosis between the natural structure of wood and a variety on graphic design. The innovative Carving technology enables us to engrave classic, retro modern and contemporary designs into naturally oiled wood surfaces. Directness, clarity and structure - Carving Club I projects these values with its honest yet sophisticated design. Its subtle charm ensures a highly recognizable value, but without intruding. Through its striking design Carving Club I is especially suited for boutiques and showrooms. It is also ideal for health & spa areas due to its non-slip surface.

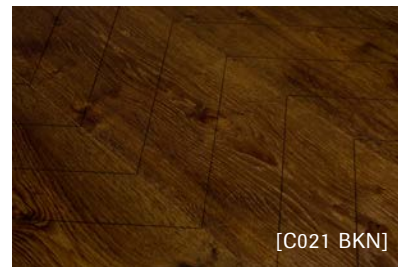

Recommended Price, excl. VAT / GST

Article Number	Dimension in mm (l x w x t)	Eur / m <sup>2</sup>
C021 <span style="display: inline-block; width: 10px; height: 10px; background-color: #808080; margin-right: 5px;"></span> <span style="display: inline-block; width: 10px; height: 10px; background-color: #808080; margin-right: 5px;"></span> 2400 240 <span style="display: inline-block; width: 10px; height: 10px; border: 1px solid black; margin-right: 5px;"></span> <span style="display: inline-block; width: 10px; height: 10px; border: 1px solid black;"></span>	2400 x 240 x 16 19	● 224.80

## LAYING FORMATS AND APPLICATIONS

Dimensions see page 9	Eur / m <sup>2</sup>	Eur / m <sup>2</sup>
Flex	● 66.00	

## SURFACES

Surfaces
<span style="border: 1px solid black; padding: 2px;">B</span> <span style="border: 1px solid black; padding: 2px;">K</span> <span style="border: 1px solid black; padding: 2px;">N</span> brushed   natural oil
<span style="border: 1px solid black; padding: 2px;">B</span> <span style="border: 1px solid black; padding: 2px;">K</span> <span style="border: 1px solid black; padding: 2px;">W</span> brushed   white oil

Suitable for underfloor heating • Area of Application P1 / P2 / O • Emissions Class E1 • Fire Rating CFL-s1 • Weight per m<sup>2</sup>: 16 mm: 10,50 kg // 19 mm: 11,50 kg

With this price list, all previous editions are invalid. Error, price and technical changes reserved. Deliveries not unloaded. Delivery only in packaging units. Variations in color and structure are natural characteristics of wood. Specified measurements are top or invoice measurements.

**mafi**

# OAK Clear Carving Check I

Structure: Plank: Symmetrical 3-layer

Bevel/joint: small bevel on the long side; tongue and groove on all sides for endless installation

Grading: The planks are free from knots and sapwood but have curled spots. Small knots and slight stress cracks are possible. Small open cracks and unsealed spots of a few millimeters are permitted.

Carving is an extraordinary symbiosis between the natural structure of wood and a variety on graphic design. The innovative Carving technology enables us to engrave classic, retro modern and contemporary designs into naturally oiled wood surfaces. Directness, clarity and structure - Carving Club I projects these values with its honest yet sophisticated design. Its subtle charm ensures a highly recognizable value, but without intruding. Through its striking design Carving Club I is especially suited for boutiques and showrooms. It is also ideal for health & spa areas due to its non-slip surface.



Recommended Price, excl. VAT / GST

Article Number	Dimension in mm (l x w x t)	Eur / m <sup>2</sup>
C022 <input checked="" type="checkbox"/> <input type="checkbox"/> <input type="checkbox"/> 2400 240 <input type="checkbox"/> <input type="checkbox"/>	2400 x 240 x 16 19	● 228.00

## LAYING FORMATS AND APPLICATIONS

Dimensions see page 9	Eur / m <sup>2</sup>	Eur / m <sup>2</sup>
Flex	● 66.00	

## SURFACES

### Surfaces

brushed | natural oil

brushed | white oil

brushed | grey oil

Suitable for underfloor heating • Area of Application P1 / P2 / O • Emissions Class E1 • Fire Rating CFL-s1 • Weight per m<sup>2</sup>: 16 mm: 10,50 kg // 19 mm: 11,50 kg

With this price list, all previous editions are invalid. Error, price and technical changes reserved. Deliveries not unloaded. Delivery only in packaging units. Variations in color and structure are natural characteristics of wood. Specified measurements are top or invoice measurements.

**mafi**

# OAK Clear Carving Lipso I

Structure: Plank: Symmetrical 3-layer

Bevel/joint: small bevel on the long side; tongue and groove on all sides for endless installation

Grading: The planks are free from knots and sapwood but have curled spots. Small knots and slight stress cracks are possible. Small open cracks and unsealed spots of a few millimeters are permitted.

Carving is an extraordinary symbiosis between the natural structure of wood and a variety on graphic design. The innovative Carving technology enables us to engrave classic, retro modern and contemporary designs into naturally oiled wood surfaces. Directness, clarity and structure - Carving Club I projects these values with its honest yet sophisticated design. Its subtle charm ensures a highly recognizable value, but without intruding. Through its striking design Carving Club I is especially suited for boutiques and showrooms. It is also ideal for health & spa areas due to its non-slip surface.

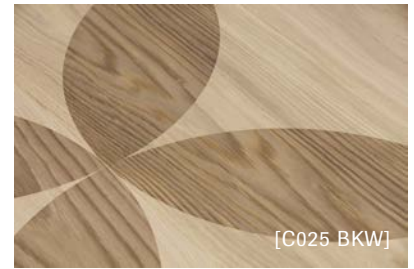

Recommended Price, excl. VAT / GST

Article Number	Dimension in mm (l x w x t)	Eur / m <sup>2</sup>
C025 <span style="display: inline-block; width: 10px; height: 10px; background-color: #808080; margin-right: 5px;"></span> <span style="display: inline-block; width: 10px; height: 10px; background-color: #808080; margin-right: 5px;"></span> <span style="display: inline-block; width: 10px; height: 10px; background-color: #808080; margin-right: 5px;"></span> 2400 240 <span style="display: inline-block; width: 10px; height: 10px; border: 1px solid black; margin-right: 5px;"></span> <span style="display: inline-block; width: 10px; height: 10px; border: 1px solid black;"></span>	2400 x 240 x 16 19	● 228.00

## LAYING FORMATS AND APPLICATIONS

Dimensions see page 9	Eur / m <sup>2</sup>	Eur / m <sup>2</sup>
Flex	● 66.00	

## SURFACES

### Surfaces

**B K N** brushed | natural oil

**B K W** brushed | white oil

**B K G** brushed | grey oil

Suitable for underfloor heating • Area of Application P1 / P2 / O • Emissions Class E1 • Fire Rating CFL-s1 • Weight per m<sup>2</sup>: 16 mm: 10,50 kg // 19 mm: 11,50 kg

With this price list, all previous editions are invalid. Error, price and technical changes reserved. Deliveries not unloaded. Delivery only in packaging units. Variations in color and structure are natural characteristics of wood. Specified measurements are top or invoice measurements.

**mafi**

# Domino LARCH Vulcano

Structure: End Grain: compact ready-to-install elements of end-grain blocks (40 x 40 mm).

Joint: Parquet net (400 x 200 mm)

Thermo treatment: heat treatment Vulcano (without chemical additives) with a continuous coloration in the cross-section of the top and back layers. Color differences in appearance are characteristic.

Grading: Isolated stress cracks and expansion gaps (e.g. due to climatic changes) are possible in the elements. These do not however influence the functionality of the floor (strength and stress bearing properties) in any way. mafi Domino floors are not oiled on the production side, but must be oiled on site after installation.

Extremely robust (suitable for ateliers and commercial properties!). Can also be used for raised floors.



INSTALLATION:

Important! Installation should only be carried out by experts and the installation guidelines must be observed.

The maximum relative humidity of cement screed may not exceed 2 CM% (with underfloor heating 1.8 CM %). Additionally, the appropriate adhesive tensile strength (min. 1.2 N/mm<sup>2</sup> - highest stress class) must be noted.



Recommended Price, excl. VAT / GST

Article Number	Dimension in mm (l x w x t)		Eur / m <sup>2</sup>
LADO  0400 200 	400 x 200 x 19		180.80

PACKING UNITS: Element: 400 x 200 x 19 mm // 10 elements = 1 Pack (0.8 m<sup>2</sup>) // 1 Euro pallet = 60 Packs (48 m<sup>2</sup>)

## SURFACES

### Surfaces

**B K N** brushed | natural oil

**B K W** brushed | white oil

**S K N** sanded | natural oil

**S K W** sanded | white oil

Suitable for underfloor heating • Area of Application P1 / P2 / O • Emissions Class E1 • Fire Rating CFL-s1 • Weight per m<sup>2</sup>: 19 mm: 10,50 kg

With this price list, all previous editions are invalid. Error, price and technical changes reserved. Deliveries not unloaded. Delivery only in packaging units. Variations in color and structure are natural characteristics of wood. Specified measurements are top or invoice measurements.

**mafi**

# Parquet Panels

Structure: Panel: multi-layer construction

Bevel/joint: small bevel on all sides; Tongue and groove on all sides for easy installation compatible with mafi planks for frieze patterns.

Grading: The boards of the OAK are mostly sound knotty. Small knots are closed with suitable wood filler. Intersections up to approx. 10mm are possible. Small open cracks and unsealed areas in the millimeter range are permissible. The boards of Oak Vulcano Medium, Oak Vulcano and Walnut are graded identically to the planks. The noble classic for an exclusive ambience offered in four different patterns (A, B, C, and D).

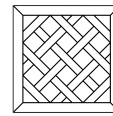
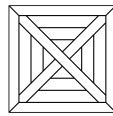
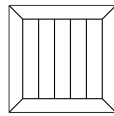
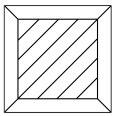

Profile	Profile	Profile	Profile
---------	---------	---------	---------

A	B	C	D
---	---	---	---

Recommended Price, excl. VAT / GST

Product/Article Number	Dimension in mm (l x w x t)	Profile	Eur / pcs.
OAK	EAYA ■■■ 0700 700 □□	A	● 177.00
OAK	EAYB ■■■ 0700 700 □□	B	● 162.70
OAK	EAYC ■■■ 0700 700 □□	C	● 195.00
OAK	EAYD ■■■ 0700 700 □□	D	● 241.60
OAK Vulcano Medium	EHYA ■■■ 0700 700 □□	A	● 188.60
OAK Vulcano Medium	EHYB ■■■ 0700 700 □□	B	● 175.70
OAK Vulcano Medium	EHYC ■■■ 0700 700 □□	C	● 205.40
OAK Vulcano Medium	EHYD ■■■ 0700 700 □□	D	● 253.20
OAK Vulcano	EVYA ■■■ 0700 700 □□	A	● 188.60
OAK Vulcano	EVYB ■■■ 0700 700 □□	B	● 174.50
OAK Vulcano	EVYC ■■■ 0700 700 □□	C	● 205.40
OAK Vulcano	EVYD ■■■ 0700 700 □□	D	● 253.20
WALNUT USA	NSYA ■■■ 0700 700 □□	A	● 248.00
WALNUT USA	NSYB ■■■ 0700 700 □□	B	● 232.40
WALNUT USA	NSYC ■■■ 0700 700 □□	C	● 267.40
WALNUT USA	NSYD ■■■ 0700 700 □□	D	● 319.00

## SURFACES

Surfaces
----------

B K N brushed | natural oil

B K W brushed | white oil



**mafi**

WALL PANELS

# Wall panels

Current living trends are clearly developing in the direction of wooden wall cladding. The mafi natural wood on the wall becomes a real eye-catcher. Clear room concepts with the attribute of sustainability can convey special warmth and security, both in the private sector, for example as a wooden wall for the bedroom, as well as for companies or practices. A particularly natural design is the result of a reduced mix of materials, which uses the same material in the choice of floor, as well as wall cladding.

## mafi planks as wall accent

A reduced mix of materials is the key to high-quality design concepts. All our natural wooden planks can also be used as wall coverings. In this way, the floor surface can be repeated specifically as an accent on the wall and, depending on its position, can accentuate an area or even visually enlarge the room.



## mafi Flex

A natural wood floor that does not adhere to conventions and deviates from its horizontal position, a natural wood floor that combines furniture, walls and ceilings with the floor, an opportunity, a source of inspiration, a solution – that's mafi Flex.

Our designs are always based on nature. Like so much already, the idea for this new way of furnishing follows a simple guiding principle: going back to the roots.

Tree trunks are round. It is only through processing by humans that the straight wooden planks that we are all so familiar with are made. So why not give back wood, as a natural material, part of its natural shape?

This is how the idea for mafi Flex came about, which makes it possible to create room concepts that seem to originate from a single source.



## BOISERIE Linear

The milling process penetrates the top layer and reveals the contrasting black middle layer. Further milling of the gaps lengthwise with subtle grooves reinforces the room-expanding effect of the flooring.

The clear, linear design is ideal for stretching room heights and accentuating internal areas.



## BOISERIE Reserve

Namely inspired by the Reserve wine label for particularly high-quality wines, this variant offers a restrained look. The discreet milling deepens the top layer without penetrating the middle layer.

This creates an interplay between the refined top layer and the second wood layer, which is interspersed with fine grooves.



# OAK Character Bosierie

Structure: Boiserie: Symmetrical 3-layer for Boiserie Reserve / Symmetrical Multilayer for Boiserie Linear

Bevel/joint: small bevel on the long side; tongue and groove on long side

Grading: For the main part the planks have healthy knots. Stress cracks up to 30 cm, also torn knots and small knots are sealed with appropriate wood putty. Repairs up to 25 mm diameter are possible. Small open cracks and unsealed spots of a few millimeters are permitted.



Recommended Price, excl. VAT / GST

Article Number	Dimension in mm (l x w x t)	Eur / m <sup>2</sup>
Reserve (WPF) EIEB ■■■ 0000 160 □□	2000/2400 x 160 x 16	● 184.20
Reserve (WPF) EIEB ■■■ 0000 190 □□	2000/2400 x 190 x 16	● 190.60
Linear (WPM) EIEB ■■■ 0000 160 □□	2000/2400 x 160 x 16	● 219.00
Linear (WPM) EIEB ■■■ 0000 190 □□	2000/2400 x 190 x 16	● 225.40

Delivery of lengths is depending on production at the time

Fixed dimensions in mm	Eur / m <sup>2</sup>
Lengths: 2000/2400	● 8.60

## SURFACES

### Surfaces

**B K N** brushed | natural oil

**B K W** brushed | white oil

**B K G** brushed | grey oil

### Surfaces with surcharge

**B T Z** brushed | deep white | natured

**B K X** brushed | extreme white oil

8.60

**B K M** brushed | 1x natural oil 1x white oil

**B K T** brushed | raw wood look

**B K A** brushed | graphite grey oil

13.30

Suitable for underfloor heating • Emissions Class E1 • Weight per m<sup>2</sup>: 16 mm: 10,50 kg

With this price list, all previous editions are invalid. Error, price and technical changes reserved. Deliveries not unloaded. Delivery only in packaging units. Variations in color and structure are natural characteristics of wood. Specified measurements are top or invoice measurements.

**mafi**

# OAK Vulcano Medium Boiserie

Structure: Boiserie: Symmetrical 3-layer for Boiserie Reserve / Symmetrical Multilayer for Boiserie Linear

Bevel/joint: small bevel on the long side; tongue and groove on long side

Thermo treatment: heat treatment Vulcano Medium (without chemical additives) with a continuous coloration in the cross-section of the top and back layers. Color differences in appearance are characteristic.

Grading: For the main part the planks have healthy knots. Stress cracks up to 30 cm, also torn knots and small knots are sealed with appropriate wood putty. Repairs up to 25 mm diameter are possible. Small open cracks and unsealed spots of a few millimeters are permitted.

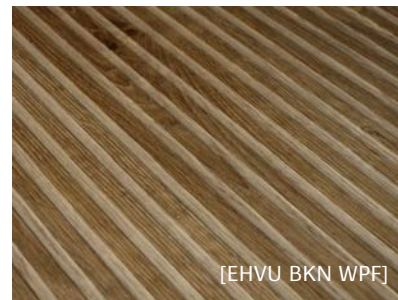

Recommended Price, excl. VAT / GST

Article Number	Dimension in mm (l x w x t)	Eur / m <sup>2</sup>
Reserve (WPF) EHVU ■■■ 0000 160 □□	2000/2400 x 160 x 16	● 213.10
Reserve (WPF) EHVU ■■■ 0000 190 □□	2000/2400 x 190 x 16	● 222.20
Linear (WPM) EHVU ■■■ 0000 160 □□	2000/2400 x 160 x 16	● 247.90
Linear (WPM) EHVU ■■■ 0000 190 □□	2000/2400 x 190 x 16	● 257.00

Delivery of lengths is depending on production at the time

Fixed dimensions in mm	Eur / m <sup>2</sup>
Lengths: 2000/2400	● 8.60

## SURFACES

### Surfaces

**B K N** brushed | natural oil

**B K W** brushed | white oil

Not Suitable for underfloor heating • Emissions Class E1 • Weight per m<sup>2</sup>: 16 mm: 10,50 kg

With this price list, all previous editions are invalid. Error, price and technical changes reserved. Deliveries not unloaded. Delivery only in packaging units. Variations in color and structure are natural characteristics of wood. Specified measurements are top or invoice measurements.

**mafi**

# OAK Vulcano Boiserie

Structure: Boiserie: Symmetrical 3-layer for Boiserie Reserve / Symmetrical Multilayer for Boiserie Linear

Bevel/joint: small bevel on the long side; tongue and groove on long side

Thermo treatment: heat treatment Vulcano (without chemical additives) with a continuous coloration in the cross-section of the top and back layers. Color differences in appearance are characteristic.

Grading: For the main part the planks have healthy knots. Stress cracks up to 30 cm, also torn knots and small knots are sealed with appropriate wood putty. Repairs up to 25 mm diameter are possible. Small open cracks and unsealed spots of a few millimeters are permitted.

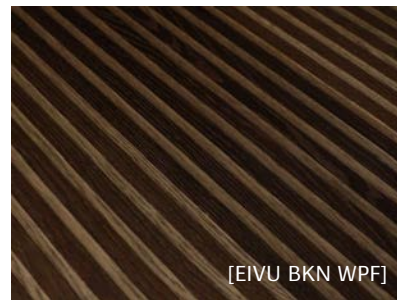

Recommended Price, excl. VAT / GST

Article Number	Dimension in mm (l x w x t)	Eur / m <sup>2</sup>
Reserve (WPF) EIVU ■■■ 0000 160 □□	2000/2400 x 160 x 16	● 213.10
Reserve (WPF) EIVU ■■■ 0000 190 □□	2000/2400 x 190 x 16	● 222.20
Linear (WPM) EIVU ■■■ 0000 160 □□	2000/2400 x 160 x 16	● 247.90
Linear (WPM) EIVU ■■■ 0000 190 □□	2000/2400 x 190 x 16	● 257.00

Delivery of lengths is depending on production at the time

Fixed dimensions in mm	Eur / m <sup>2</sup>
Lengths: 2000/2400	● 8.60

## SURFACES

### Surfaces

**B K N** brushed | natural oil

**B K W** brushed | white oil

Not Suitable for underfloor heating • Emissions Class E1 • Weight per m<sup>2</sup>: 16 mm: 10,50 kg

With this price list, all previous editions are invalid. Error, price and technical changes reserved. Deliveries not unloaded. Delivery only in packaging units. Variations in color and structure are natural characteristics of wood. Specified measurements are top or invoice measurements.

**mafi**

# SWISS STONE PINE Boiserie

Structure: Boiserie: Symmetrical 3-layer for Boiserie Reserve / Symmetrical Multilayer for Boiserie Linear

Bevel/joint: small bevel on the long side; tongue and groove on long side

Grading: Typical surface with large knots up to 100 mm diameter and sapwood (around 1/3 of the plank). Isolated sealed cracks up to max. 1/3 of plank length are possible; stress cracks in the knots and small cracks of up to max. 25 mm diameter are also closed with appropriate wood putty. Small open cracks and unsealed spots of a few millimeters are permitted.



Recommended Price, excl. VAT / GST

Article Number		Dimension in mm (l x w x t)	Eur / m <sup>2</sup>
Reserve (WPF)	ZIEB ■■■ 0000 155 □□	1980/2480 x 155 x 16	● 198.80
Reserve (WPF)	ZIEB ■■■ 0000 190 □□	1980/2480 x 190 x 16	● 198.80
Linear (WPM)	ZIEB ■■■ 0000 155 □□	1980/2480 x 155 x 16	● 233.60
Linear (WPM)	ZIEB ■■■ 0000 190 □□	1980/2480 x 190 x 16	● 233.60

Delivery of lengths is depending on production at the time

Fixed dimensions in mm	Eur / m <sup>2</sup>
Lengths: 2000/2400	● 8.60

## SURFACES

### Surfaces

**B K N** brushed | natural oil

**B K W** brushed | white oil

Not Suitable for underfloor heating • Emissions Class E1 • Weight per m<sup>2</sup>: 16 mm: 7,08 kg

With this price list, all previous editions are invalid. Error, price and technical changes reserved. Deliveries not unloaded. Delivery only in packaging units. Variations in color and structure are natural characteristics of wood. Specified measurements are top or invoice measurements.

**mafi**

# Accessoires for wall and ceiling mounting

## Wall mounting screws

Special screws with a small head and Torx thread (3.2 x 40 mm) for wall mounting of mafi natural wood planks. 400 pieces per packaging unit.

			Recommended Price, excl. VAT / GST
Product	Article Number	Dimension/Packaging unit	Eur / Box
Wall mounting screws	VMSCHRAUBE001	400 pieces	18.50

**mafi**

ACCESSORIES



# Skirting board to match the floor

The skirting boards are manufactured from natural wood planks in a three-layer structure as in the sketch. The structure is composed of approx. 4 mm top layer and approx. 4 mm backing of the same type of wood, between which there is a soft wood middle layer. The skirtings are contoured, glued without formaldehyde and slightly broken at the visible edge.

As a result of the joint production of the floor and baseboard, any differences in appearance are reduced, and better distortion behavior is also achieved.

The baseboards are available in four different height profiles. Purchase only in bundles. Individual skirtings are not for sale.



✓ **Matching the floor**

✓ **Matching sealant color**

✓ **Purchase in bundle**

Profile	Bundle	Meter
Profile I	4 Pcs.	9,6 m
Profile J	3 Pcs.	7,2 m
Profile K	2 Pcs.	4,8 m
Profile L	3 Pcs.	7,2 m

Product	Skirting
OAK / Coral OAK / Carving OAK	OAK Character
OAK Vulcano Medium / OAK Country Vulcano Medium	OAK Vulcano Medium
OAK Vulcano / OAK Country Vulcano / Tiger OAK / Coral OAK Vulcano / Carving OAK Vulcano	OAK Vulcano
Nero OAK	Nero OAK
COR ASH	COR ASH
UNI ASH	UNI ASH
ASH Vulcano Medium	ASH Vulcano Medium
WALNUT USA	on request
DOUGLAS FIR	on request
LARCH / LARCH Country	LARCH
LARCH Vulcano	LARCH Vulcano
FIR	SPRUCE
Swiss Stone Pine	SPRUCE
SPRUCE	SPRUCE

# Skirtings in symmetrical 3-layer construction

## OAK

Skirtings made of natural wood planks in three-layer construction according to sketch. The structure is composed of approx. 4 mm top layer and approx. 4 mm backing of the same type of wood, between which there is a soft wood middle layer. The skirtings are contoured, glued without formaldehyde, and slightly broken at the visible edge.

As a result of the joint production of the floor and skirting, differences in the way they look are reduced and better warping behavior is also achieved. Sorting criteria can be found in the respective wooden floor sorting.



Profile I	Profile J	Profile K	Profile L
Dimensions in mm (l x t x h)	Dimensions in mm (l x t x h)	Dimensions in mm (l x t x h)	Dimensions in mm (l x t x h)
2400 x 020 x 16 mm	2400 x 040 x 16 mm	2400 x 060 x 16 mm	2400 x 057 x 16 mm

Recommended Price, excl. VAT / GST

Product/Article Number	Profile	Dimensions in mm (l x t x h)	Eur / rm.
OAK Charakter	EIS I	2400 020 016	15.60
OAK Charakter	EIS J	2400 040 016	18.00
OAK Charakter	EIS K	2400 060 016	23.20
OAK Charakter	EIS L	2400 057 016	18.00
OAK Vulcano Medium	EHS I	2400 020 016	16.80
OAK Vulcano Medium	EHS J	2400 040 016	19.40
OAK Vulcano Medium	EHS K	2400 060 016	25.80
OAK Vulcano Medium	EHS L	2400 057 016	19.40
OAK Vulcano	EVS I	2400 020 016	16.80
OAK Vulcano	EVS J	2400 040 016	19.40
OAK Vulcano	EVS K	2400 060 016	25.80
OAK Vulcano	EVS L	2400 057 016	19.40
Nero OAK Vulcano	VNS I	2400 020 016	16.80
Nero OAK Vulcano	VNS J	2400 040 016	19.40
Nero OAK Vulcano	VNS K	2400 060 016	25.80
Nero OAK Vulcano	VNS L	2400 057 016	19.40

# Skirtings in symmetrical 3-layer construction

## ASH

Skirtings made of natural wood planks in three-layer construction according to sketch. The structure is composed of approx. 4 mm top layer and approx. 4 mm backing of the same type of wood, between which there is a soft wood middle layer. The skirtings are contoured, glued without formaldehyde, and slightly broken at the visible edge.

As a result of the joint production of the floor and skirting, differences in the way they look are reduced and better warping behavior is also achieved. Sorting criteria can be found in the respective wooden floor sorting.

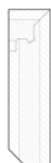

Profile I	Profile J	Profile K	Profile L
Dimensions in mm (l x t x h)	Dimensions in mm (l x t x h)	Dimensions in mm (l x t x h)	Dimensions in mm (l x t x h)
2400 x 020 x 16 mm	2400 x 040 x 16 mm	2400 x 060 x 16 mm	2400 x 057 x 16 mm

Recommended Price, excl. VAT / GST

Product/Article Number	Profile	Dimensions in mm (l x t x h)	Eur / rm.
COR ASH	CES I	2400 020 016	13.00
COR ASH	CES J	2400 040 016	15.60
COR ASH	CES K	2400 060 016	19.40
COR ASH	CES L	2400 057 016	15.60
UNI ASH	WES I	2400 020 016	14.20
UNI ASH	WES J	2400 040 016	15.60
UNI ASH	WES K	2400 060 016	20.60
UNI ASH	WES L	2400 057 016	15.60
ASH Vulcano Medium	EMS I	2400 020 016	16.80
ASH Vulcano Medium	EMS J	2400 040 016	19.40
ASH Vulcano Medium	EMS K	2400 060 016	25.80
ASH Vulcano Medium	EMS L	2400 057 016	19.40

# Skirtings in symmetrical 3-layer construction

## LARCH & SPRUCE

Skirtings made of natural wood planks in three-layer construction according to sketch. The structure is composed of approx. 4 mm top layer and approx. 4 mm backing of the same type of wood, between which there is a soft wood middle layer. The skirtings are contoured, glued without formaldehyde, and slightly broken at the visible edge.

As a result of the joint production of the floor and skirting, differences in the way they look are reduced and better warping behavior is also achieved. Sorting criteria can be found in the respective wooden floor sorting.

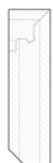

Profile I	Profile J	Profile K	Profile L
Dimensions in mm (l x t x h)	Dimensions in mm (l x t x h)	Dimensions in mm (l x t x h)	Dimensions in mm (l x t x h)
2400 x 020 x 16 mm	2400 x 040 x 16 mm	2400 x 060 x 16 mm	2400 x 057 x 16 mm

Recommended Price, excl. VAT / GST

Product/Article Number	Profile	Dimensions in mm (l x t x h)	Eur / rm.
LARCH	LAS I	2400 020 016	13.00
LARCH	LAS J	2400 040 016	14.20
LARCH	LAS K	2400 060 016	18.00
LARCH	LAS L	2400 057 016	14.20
LARCH Vulcano	LVS I	2400 020 016	14.20
LARCH Vulcano	LVS J	2400 040 016	16.80
LARCH Vulcano	LVS K	2400 060 016	20.60
LARCH Vulcano	LVS L	2400 057 016	16.80
SPRUCE	FIS I	2400 020 016	10.30
SPRUCE	FIS J	2400 040 016	11.60
SPRUCE	FIS K	2400 060 016	14.20
SPRUCE	FIS L	2400 057 016	11.60

# Minileiste

Mini strip to transition between your wood floors and the wall. 3 pcs. of wall clamps are included by running meter. Replacement clamps available on request.

This strip enables a new aesthetic for the transitions between room elements or between floor and wall. This system's design focuses on the maxims of clean, modern aesthetics and the highest possible ease of installation. Used where connection and expansion joints have to be kept from a structural point of view, this strip can be used as an end or transition profile.

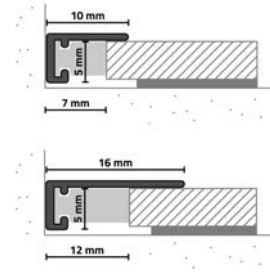

Recommended Price, excl. VAT / GST

Product	Article Number	Dimension/Packaging unit	Eur / rm.
minileiste AL10X5 black 2000x010x5mm	MLSW1052000010005	Delivered as pcs.	13.80
minileiste AL16X5 black 2000x016x5mm	MLSW1652000016005	Delivered as pcs.	13.80
minileiste AL16X5 titanium 2000x060x15mm	MLTT1052000010005	Delivered as pcs.	13.80
minileiste AL16X5 titanium 2000x016x5mm	MLTT1652000016005	Delivered as pcs.	13.80

# Stairs 1/2

mafi stairs in OAK (see variants below) are manufactured in symmetrical 3-layer construction design from lamellas (Multi-layer), joiner multiplex sheet and lamellas (Multi-layer). The stair nosing can optionally be manufactured with a rounded ( $r = 4 \text{ mm}$ ) or a bevel ( $3 \text{ mm}$ ) edge. Finished surface top and front. For all stairways, the visible sides can also be finished (closed) at a surcharge. Stairs matching the entire mafi portfolio may, in addition to the examples cited here, be produced on request. Non-visible sides with oversize. Use the stair form for ordering.

**Profile A:** 1200 x 300 x 40 mm (Standard dimension unless explicitly specified otherwise)

Special thicknesses possible  $> = 30 \text{ mm}$

**Profile B:** 1200 x 300 x 16 | 19 mm (Standard dimension unless explicitly specified otherwise)

Special thicknesses possible  $< 30 \text{ mm}$

**Profile D:** 1200 x 300 (step) / 180 (riser) x 40 mm

Pre-drilled and provided with tongue for assembly on site. Optionally without shadow groove. Separate tongue loose. Delivered by the piece (no bundling)

**Profile E:** 1200 x 300 x 16 | 19 mm (Edge mitred ready glued. Mitre 40 mm)

**Profile F:** 1200 x 300 (step) / 180 (riser) x 16 | 19 mm (Edge mitred ready glued)

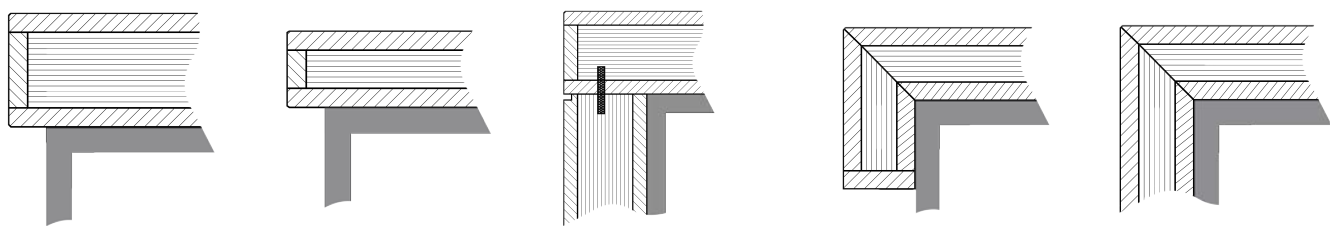

Profile	Profile	Profile	Profile	Profile
A	B	D	E	F

Recommended Price, excl. VAT / GST

Product/Article Number	Dimension in mm (l x w x t)	Profile	Eur / pcs.
Oak Clear	EAMH <input type="checkbox"/> <input type="checkbox"/> <input type="checkbox"/> <input type="checkbox"/> <input type="checkbox"/> <input type="checkbox"/> <input type="checkbox"/> <input type="checkbox"/> <input type="checkbox"/> <input type="checkbox"/> <input type="checkbox"/>	A	222.20
Oak Clear	EAMH <input type="checkbox"/> <input type="checkbox"/> <input type="checkbox"/> <input type="checkbox"/> <input type="checkbox"/> <input type="checkbox"/> <input type="checkbox"/> <input type="checkbox"/> <input type="checkbox"/> <input type="checkbox"/>	B	171.80
Oak Clear	EAMH <input type="checkbox"/> <input type="checkbox"/> <input type="checkbox"/> <input type="checkbox"/> <input type="checkbox"/> <input type="checkbox"/> <input type="checkbox"/> <input type="checkbox"/> <input type="checkbox"/> <input type="checkbox"/>	D	313.90
Oak Clear	EAMH <input type="checkbox"/> <input type="checkbox"/> <input type="checkbox"/> <input type="checkbox"/> <input type="checkbox"/> <input type="checkbox"/> <input type="checkbox"/> <input type="checkbox"/> <input type="checkbox"/> <input type="checkbox"/>	E	246.70
Oak Clear	EAMH <input type="checkbox"/> <input type="checkbox"/> <input type="checkbox"/> <input type="checkbox"/> <input type="checkbox"/> <input type="checkbox"/> <input type="checkbox"/> <input type="checkbox"/> <input type="checkbox"/> <input type="checkbox"/>	F	307.30
OAK Character	EIMH <input type="checkbox"/> <input type="checkbox"/> <input type="checkbox"/> <input type="checkbox"/> <input type="checkbox"/> <input type="checkbox"/> <input type="checkbox"/> <input type="checkbox"/> <input type="checkbox"/> <input type="checkbox"/>	A	222.20
OAK Character	EIMH <input type="checkbox"/> <input type="checkbox"/> <input type="checkbox"/> <input type="checkbox"/> <input type="checkbox"/> <input type="checkbox"/> <input type="checkbox"/> <input type="checkbox"/> <input type="checkbox"/> <input type="checkbox"/>	B	171.80
OAK Character	EIMH <input type="checkbox"/> <input type="checkbox"/> <input type="checkbox"/> <input type="checkbox"/> <input type="checkbox"/> <input type="checkbox"/> <input type="checkbox"/> <input type="checkbox"/> <input type="checkbox"/> <input type="checkbox"/>	D	313.90
OAK Character	EIMH <input type="checkbox"/> <input type="checkbox"/> <input type="checkbox"/> <input type="checkbox"/> <input type="checkbox"/> <input type="checkbox"/> <input type="checkbox"/> <input type="checkbox"/> <input type="checkbox"/> <input type="checkbox"/>	E	246.70
OAK Character	EIMH <input type="checkbox"/> <input type="checkbox"/> <input type="checkbox"/> <input type="checkbox"/> <input type="checkbox"/> <input type="checkbox"/> <input type="checkbox"/> <input type="checkbox"/> <input type="checkbox"/> <input type="checkbox"/>	F	307.30

## LAYING FORMATS AND APPLICATIONS

Dimensions see page 9	Eur / pcs.	Eur / pcs.
Extra charge for additional side section Profile A + B	8.60	Extra charge for additional side section Profile D + E + F 15.60

## SURFACES

Surfaces
<input type="checkbox"/> <input type="checkbox"/> <input type="checkbox"/> brushed   natural oil
<input type="checkbox"/> <input type="checkbox"/> <input type="checkbox"/> brushed   white oil

# Stairs 2/2

mafi stairs in OAK (see variants below) are manufactured in symmetrical 3-layer construction design from lamellas (Multi-layer), joiner multiplex sheet and lamellas (Multi-layer). The stair nosing can optionally be manufactured with a rounded ( $r = 4 \text{ mm}$ ) or a bevel ( $3 \text{ mm}$ ) edge. Finished surface top and front. For all stairways, the visible sides can also be finished (closed) at a surcharge. Stairs matching the entire mafi portfolio may, in addition to the examples cited here, be produced on request. Non-visible sides with oversize. Use the stair form for ordering.

**Profile A:** 1200 x 300 x 40 mm (Standard dimension unless explicitly specified otherwise)

Special thicknesses possible  $> = 30 \text{ mm}$

**Profile B:** 1200 x 300 x 16 | 19 mm (Standard dimension unless explicitly specified otherwise)

Special thicknesses possible  $< 30 \text{ mm}$

**Profile D:** 1200 x 300 (step) / 180 (riser) x 40 mm

Pre-drilled and provided with tongue for assembly on site. Optionally without shadow groove. Separate tongue loose. Delivered by the piece (no bundling)

**Profile E:** 1200 x 300 x 16 | 19 mm (Edge mitred ready glued. Mitre 40 mm)

**Profile F:** 1200 x 300 (step) / 180 (riser) x 16 | 19 mm (Edge mitred ready glued)

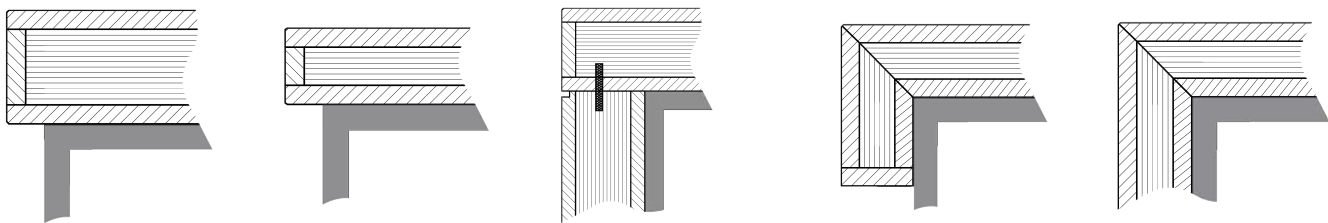

Profile	Profile	Profile	Profile	Profile
A	B	D	E	F

Recommended Price, excl. VAT / GST

Product/Article Number	Dimension in mm (l x w x t)	Profile	Eur / pcs.
Oak Country	ECMH <input type="checkbox"/> <input type="checkbox"/> <input type="checkbox"/> <input type="checkbox"/> <input type="checkbox"/> <input type="checkbox"/> <input type="checkbox"/> <input type="checkbox"/> <input type="checkbox"/> <input type="checkbox"/>	A	222.20
Oak Country	ECMH <input type="checkbox"/> <input type="checkbox"/> <input type="checkbox"/> <input type="checkbox"/> <input type="checkbox"/> <input type="checkbox"/> <input type="checkbox"/> <input type="checkbox"/> <input type="checkbox"/> <input type="checkbox"/>	B	171.80
Oak Country	ECMH <input type="checkbox"/> <input type="checkbox"/> <input type="checkbox"/> <input type="checkbox"/> <input type="checkbox"/> <input type="checkbox"/> <input type="checkbox"/> <input type="checkbox"/> <input type="checkbox"/> <input type="checkbox"/>	D	313.90
Oak Country	ECMH <input type="checkbox"/> <input type="checkbox"/> <input type="checkbox"/> <input type="checkbox"/> <input type="checkbox"/> <input type="checkbox"/> <input type="checkbox"/> <input type="checkbox"/> <input type="checkbox"/> <input type="checkbox"/>	E	246.70
Oak Country	ECMH <input type="checkbox"/> <input type="checkbox"/> <input type="checkbox"/> <input type="checkbox"/> <input type="checkbox"/> <input type="checkbox"/> <input type="checkbox"/> <input type="checkbox"/> <input type="checkbox"/> <input type="checkbox"/>	F	307.30
Oak Vulcano	EIMV <input type="checkbox"/> <input type="checkbox"/> <input type="checkbox"/> <input type="checkbox"/> <input type="checkbox"/> <input type="checkbox"/> <input type="checkbox"/> <input type="checkbox"/> <input type="checkbox"/> <input type="checkbox"/>	A	231.20
Oak Vulcano	EIMV <input type="checkbox"/> <input type="checkbox"/> <input type="checkbox"/> <input type="checkbox"/> <input type="checkbox"/> <input type="checkbox"/> <input type="checkbox"/> <input type="checkbox"/> <input type="checkbox"/> <input type="checkbox"/>	B	175.70
Oak Vulcano	EIMV <input type="checkbox"/> <input type="checkbox"/> <input type="checkbox"/> <input type="checkbox"/> <input type="checkbox"/> <input type="checkbox"/> <input type="checkbox"/> <input type="checkbox"/> <input type="checkbox"/> <input type="checkbox"/>	D	308.80
Oak Vulcano	EIMV <input type="checkbox"/> <input type="checkbox"/> <input type="checkbox"/> <input type="checkbox"/> <input type="checkbox"/> <input type="checkbox"/> <input type="checkbox"/> <input type="checkbox"/> <input type="checkbox"/> <input type="checkbox"/>	E	254.40
Oak Vulcano	EIMV <input type="checkbox"/> <input type="checkbox"/> <input type="checkbox"/> <input type="checkbox"/> <input type="checkbox"/> <input type="checkbox"/> <input type="checkbox"/> <input type="checkbox"/> <input type="checkbox"/> <input type="checkbox"/>	F	313.90

## LAYING FORMATS AND APPLICATIONS

Dimensions see page 9	Eur / pcs.	Eur / pcs.
Extra charge for additional side section Profile A + B	8.60	Extra charge for additional side section Profile D + E + F 15.60

## SURFACES

Surfaces
----------

**B K N** brushed | natural oil

**B K W** brushed | white oil

# Wood STAIR NOSES - OAK

Stair nosing profile made of natural wood planks in three-layer construction according to sketch. The structure consists of approx. 4 mm top layer and approx. 4 mm counter layer of the same wood species, with a softwood middle layer in between. The battens are mitered, glued without formaldehyde and slightly broken at the visible edge.

The joint production of base and strips reduces any visual deviations and also achieves better warpage behavior. For grading criteria, please refer to the respective wood flooring grades.

Acceptance is only possible in bundles of 2 pieces (4.8 linear meters). Single stair nosings are not for sale.

Structure and color differences are in the nature of the wood!

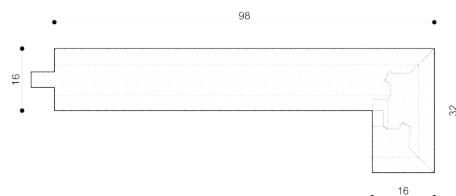
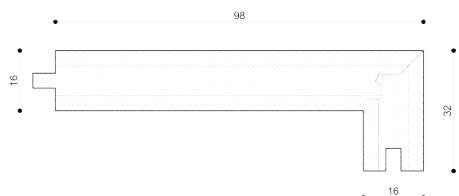

## Profile G

Dimensions in mm (l x t x h)

2400 x 032 x 16 mm

2400 x 032 x 19 mm

## Profile H

Dimensions in mm (l x t x h)

2400 x 032 x 16 mm

2400 x 032 x 19 mm

Recommended Price, excl. VAT / GST

Product/Article Number	Profile		Dimensions in mm (l x t x h)	Eur / rm.
OAK Clear	EAT	G	■ ■ ■ ■ □ □ □ □ □ □ □ □	Dimensions depending on profile 35.20
OAK Clear	EAT	H	■ ■ ■ ■ □ □ □ □ □ □ □ □	Dimensions depending on profile 46.40
OAK Character	EIT	G	■ ■ ■ ■ □ □ □ □ □ □ □ □	Dimensions depending on profile 32.60
OAK Character	EIT	H	■ ■ ■ ■ □ □ □ □ □ □ □ □	Dimensions depending on profile 42.60
OAK Sand	E5T	G	■ ■ ■ ■ □ □ □ □ □ □ □ □	Dimensions depending on profile 27.60
OAK Sand	E5T	H	■ ■ ■ ■ □ □ □ □ □ □ □ □	Dimensions depending on profile 36.40
OAK Country gold	E2T	G	■ ■ ■ ■ □ □ □ □ □ □ □ □	Dimensions depending on profile 27.60
OAK Country gold	E2T	H	■ ■ ■ ■ □ □ □ □ □ □ □ □	Dimensions depending on profile 36.40
OAK Country	ECT	G	■ ■ ■ ■ □ □ □ □ □ □ □ □	Dimensions depending on profile 27.60
OAK Country	ECT	H	■ ■ ■ ■ □ □ □ □ □ □ □ □	Dimensions depending on profile 35.20
OAK Vulcano Medium	EHT	G	■ ■ ■ ■ □ □ □ □ □ □ □ □	Dimensions depending on profile 37.70
OAK Vulcano Medium	EHT	H	■ ■ ■ ■ □ □ □ □ □ □ □ □	Dimensions depending on profile 49.00
OAK Vulcano	EVT	G	■ ■ ■ ■ □ □ □ □ □ □ □ □	Dimensions depending on profile 37.70
OAK Vulcano	EVT	H	■ ■ ■ ■ □ □ □ □ □ □ □ □	Dimensions depending on profile 49.00
Nero OAK Vulcano	VNT	G	■ ■ ■ ■ □ □ □ □ □ □ □ □	Dimensions depending on profile 37.70
Nero OAK Vulcano	VNT	H	■ ■ ■ ■ □ □ □ □ □ □ □ □	Dimensions depending on profile 49.00



# Wood STAIR NOSES - CONIFER

Stair nosing profile made of natural wood planks in three-layer construction according to sketch. The structure consists of approx. 4 mm top layer and approx. 4 mm counter layer of the same wood species, with a softwood middle layer in between. The battens are mitered, glued without formaldehyde and slightly broken at the visible edge.

The joint production of base and strips reduces any visual deviations and also achieves better warpage behavior. For grading criteria, please refer to the respective wood flooring grades.

Acceptance is only possible in bundles of 2 pieces (4.8 linear meters). Single stair nosings are not for sale.

Structure and color differences are in the nature of the wood!

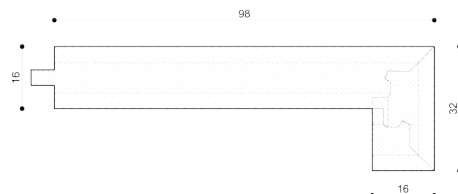

## Profile G

Dimensions in mm (l x t x h)

2400 x 032 x 16 mm

2400 x 032 x 19 mm

## Profile H

Dimensions in mm (l x t x h)

2400 x 032 x 16 mm

2400 x 032 x 19 mm

Recommended Price, excl. VAT / GST

Product/Article Number	Profile		Dimensions in mm (l x t x h)	Eur / rm.
LARCH	LAT	G	■ ■ ■ ■ □ □ □ □ □ □ □ □	Dimensions depending on profile 25.10
LARCH	LAT	H	■ ■ ■ ■ □ □ □ □ □ □ □ □	Dimensions depending on profile 32.60
LARCH Vulcano	LVT	G	■ ■ ■ ■ □ □ □ □ □ □ □ □	Dimensions depending on profile 28.80
LARCH Vulcano	LVT	H	■ ■ ■ ■ □ □ □ □ □ □ □ □	Dimensions depending on profile 38.90
DOUGLAS FIR	DOT	G	■ ■ ■ ■ □ □ □ □ □ □ □ □	Dimensions depending on profile 26.40
DOUGLAS FIR	DOT	H	■ ■ ■ ■ □ □ □ □ □ □ □ □	Dimensions depending on profile 33.80
FIR	TAT	G	■ ■ ■ ■ □ □ □ □ □ □ □ □	Dimensions depending on profile 21.40
FIR	TAT	H	■ ■ ■ ■ □ □ □ □ □ □ □ □	Dimensions depending on profile 28.80
SWISS STONE PINE	ZIT	G	■ ■ ■ ■ □ □ □ □ □ □ □ □	Dimensions depending on profile 33.80
SWISS STONE PINE	ZIT	H	■ ■ ■ ■ □ □ □ □ □ □ □ □	Dimensions depending on profile 43.90
SPRUCE	FIT	G	■ ■ ■ ■ □ □ □ □ □ □ □ □	Dimensions depending on profile 18.80
SPRUCE	FIT	H	■ ■ ■ ■ □ □ □ □ □ □ □ □	Dimensions depending on profile 23.90

# Wood STAIR NOSES - ASH & WALNUT

Stair nosing profile made of natural wood planks in three-layer construction according to sketch. The structure consists of approx. 4 mm top layer and approx. 4 mm counter layer of the same wood species, with a softwood middle layer in between. The battens are mitered, glued without formaldehyde and slightly broken at the visible edge.

The joint production of base and strips reduces any visual deviations and also achieves better warpage behavior. For grading criteria, please refer to the respective wood flooring grades.

Acceptance is only possible in bundles of 2 pieces (4.8 linear meters). Single stair nosings are not for sale.

Structure and color differences are in the nature of the wood!

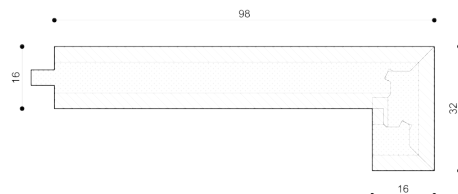

## Profile G

Dimensions in mm (l x t x h)

2400 x 032 x 16 mm

2400 x 032 x 19 mm

## Profile H

Dimensions in mm (l x t x h)

2400 x 032 x 16 mm

2400 x 032 x 19 mm

Recommended Price, excl. VAT / GST

Product/Article Number	Profile		Dimensions in mm (l x t x h)	Eur / rm.
UNI ASH	WET	G	■ ■ ■ ■ □ □ □ □ □ □ □ □	Dimensions depending on profile 27.60
UNI ASH	WET	H	■ ■ ■ ■ □ □ □ □ □ □ □ □	Dimensions depending on profile 36.40
COR ASH	CET	G	■ ■ ■ ■ □ □ □ □ □ □ □ □	Dimensions depending on profile 26.40
COR ASH	CET	H	■ ■ ■ ■ □ □ □ □ □ □ □ □	Dimensions depending on profile 35.20
ASH Vulcano Medium	EMT	G	■ ■ ■ ■ □ □ □ □ □ □ □ □	Dimensions depending on profile 30.10
ASH Vulcano Medium	EMT	H	■ ■ ■ ■ □ □ □ □ □ □ □ □	Dimensions depending on profile 38.90
WALNUT	NUT	G	■ ■ ■ ■ □ □ □ □ □ □ □ □	Dimensions depending on profile 50.20
WALNUT	NUT	H	■ ■ ■ ■ □ □ □ □ □ □ □ □	Dimensions depending on profile 65.20

# Cork Underlay

Sold by roll.

Recommended Price, excl. VAT / GST

Product	Article Number	Dimension/Packaging unit	Eur / pcs.
Cork underlay thickness: 2 mm	KOUB000001000102	rolls of 10 x 1 m = 10 m <sup>2</sup>	64.80
Cork underlay thickness: 2 mm	KOUB000003000102	rolls of 30 x 1 m = 30 m <sup>2</sup>	184.80
Cork underlay thickness: 4 mm	KOUB000001000104	rolls of 10 x 1 m = 10 m <sup>2</sup>	180.00

# PU-Mat

PRODUCT DESCRIPTION: Ideal for underfloor heating; greatly reduces impact sound. High reduction of impact noise (17dB).

Area thermal insulation: 0.034 m<sup>2</sup> K/W.

Sold by roll. 2 mm thickness // Rolls of 30 x 1 m

Recommended Price, excl. VAT / GST

Product	Article Number	Dimension/Packaging unit	Eur / pcs.
rubber mat - ideal for underfloor heating Underlay thickness: 2mm rolls of 30 x 1m	KFUBARDEXDS102	Rolls of 30000 x 1000 x 2 mm = 30 m <sup>2</sup>	468.00

# Protection Mat Fleece

PRODUCT DESCRIPTION: For protection of wooden floors after the installation.

Sold by roll.

30000 x 1500 x 3 mm

50 m<sup>2</sup>

Recommended Price, excl. VAT / GST

Product	Article Number	Dimension/Packaging unit	Eur / pcs.
floor protection mat	BSMA50000100002		268.80

# Underlay Mat with slots

COVERAGE: 1.000 - 1.200 g/m<sup>2</sup> depending on the condition of the substrate.

AREA OF APPLICATION: Underlay mat with symmetrical slots for adhesion in strips, thickness 3 mm. Suitable for underfloor heating.

Improves footfall sound insulation. Sold by roll 20 x 1 m = 20 m<sup>2</sup>

Recommended Price, excl. VAT / GST

Product	Article Number	Dimension/Packaging unit	Eur / pcs.
Underlay Mat with slots	SKUBLAY002000103	rolls of 20000 x 1000 x cm 3 mm = 20 m <sup>2</sup>	190.80

# Adhesive

## mafi Connect - Parquet Adhesive

AREA OF APPLICATION: Adhesive for multi-layer wood flooring. Low emissions  
After curing, the 1-component adhesive remains elastic.

Content: 18kg

Consumption: approx. 1kg for 0,7m<sup>2</sup>



Recommended Price, excl. VAT / GST

Product	Article Number	Dimension/Packaging unit	Eur / pcs.
mafi Connect - Parquet Adhesive	ARDKLEBER	1 container = 18 kg	210.00

## Glue / Floating Installation

### Glue D6085

COVERAGE: One bottle covers approx. 15 - 20 m<sup>2</sup>. For tongue / groove gluing.

AREA OF APPLICATION: For all gluing to high standards and for gluing of joints of floor planks (tongue / groove gluing). Quality Class D3. STORAGE: Do not store below +5° C - SUSCEPTIBLE TO FROST.

Recommended Price, excl. VAT / GST

Product	Article Number	Dimension/Packaging unit	Eur / Can
Glue (in handy bottle)	WKUB000608500750	750 g / bottle	16.80

## Cleaning during laying

### Cleaning Cloths RT 5960

AREA OF APPLICATION: Impregnated, highly absorbent cloths for cleaning hands and tools, surfaces of ready installed parquet and smooth covering, particularly when soiled with non-hardened PU adhesives, oil, grease and lacquer. Resealable after removal of cloth.

Recommended Price, excl. VAT / GST

Product	Article Number	Dimension/Packaging unit	Eur / Can
RT 5960 - Cleaning cloths	WKUB000596000150	1 container = 150 pcs.	58.80

# Expansion joints in wood flooring

## Round cord seal

PRODUCT DESCRIPTION: To fill separating joints. Reduces the consumption of grout.

Recommended Price, excl. VAT / GST

Product	Article Number	Dimension/Packaging unit	Eur / pcs.
Joint cord 6 mm 1 carton = 100 m	BLZURS06	1 carton = 100 m	33.60

## Alkoxy Joint Compound

[for filling separation joints]

PRODUCT DESCRIPTION: For edge joints and smaller separation joints. Cannot be sanded!

COLOUR: more colours on request

Recommended Price, excl. VAT / GST

Product	Article Number	Dimension/Packaging unit	Eur / pcs.
Sealing material Alkoxy OAK	BLZUFM010310EI	310 ml cartridge	19.80
Sealing material Alkoxy TABACCO	BLZUFM010310TB	310 ml cartridge	19.80

## Laying tools

### Hammering Block

The hammering block has been specially designed for mafi planks.

The optimal fit onto the top layer and the tongue piece ensures force is applied evenly and at the same time prevents contact with any adhesive bed.



Recommended Price, excl. VAT / GST

Product	Article Number	Dimension/Packaging unit	Eur / pcs.
Push Bar Accessories with handle	BLZUSK002	1 piece	67.20

### Toothed Trowel B13

To achieve optimum floorboard adhesion, it is necessary to have enough contact points between the boards and glue.

Due to the higher adhesive lines, optimum adhesion is especially supported in long boards.



Recommended Price, excl. VAT / GST

Product	Article Number	Dimension/Packaging unit	Eur / pcs.
One way - spreader	WKUB000SPACEW00	1 piece	7.20

**mafi**

CARE

# Care products

## Wood floor oil

mafi wooden floor oil is for light re-oiling after installation. This gives the customer a perfect surface and also helps build resilience. The oil is ideally applied using a white pad and a single disc polishing machine. The floor must be re-polished afterwards with a sheep's wool pad. The oil is flammable - therefore all cloths/pads must be immersed in water after use and disposed of correctly outdoors.



## Wood floor oil natural

Coverage per litre: approx. 60 - 90 m<sup>2</sup> (depending on the absorbability of the wood) when treating previously oiled floors / approx. 8 - 12 m<sup>2</sup> for 2 applications on untreated wood

Recommended Price, excl. VAT / GST

Product	Article Number	Dimension/Packaging unit	Eur / Can
Wood floor oil natural 1 l single container	HOPP00N0010001	1 l single container	38.40
Wood floor oil natural 1 l 6 pcs./box	HOPP00N0010006	1 l x 6 pc./carton	201.60
Wood floor oil natural 2,5 l single container	HOPP00N0025001	2,5 l single container	79.20
Wood floor oil natural 2,5 l 4 pcs./box	HOPP00N0025004	2,5 l x 4 pc./carton	292.80

## Wood floor oil white

Coverage per litre: approx. 60 - 90 m<sup>2</sup> (depending on the absorbability of the wood) when treating previously oiled floors / approx. 8 - 12 m<sup>2</sup> for 2 applications on untreated wood

Recommended Price, excl. VAT / GST

Product	Article Number	Dimension/Packaging unit	Eur / Can
Wood floor oil white 1 l single container	HOPP00W0010001	1 l single container	39.60
Wood floor oil white 1 l 6 pcs./box	HOPP00W0010006	1 l x 6 pc./carton	204.00
Wood floor oil white 2,5 l single container	HOPP00W0025001	2,5 l single container	84.00
Wood floor oil white 2,5 l 4 pcs./box	HOPP00W0025004	2,5 l x 4 pc./carton	297.60

## Wood floor oil grey

Coverage per litre: approx. 60 - 90 m<sup>2</sup> (depending on the absorbability of the wood) when treating previously oiled floors / approx. 8 - 12 m<sup>2</sup> for 2 applications on untreated wood

Recommended Price, excl. VAT / GST

Product	Article Number	Dimension/Packaging unit	Eur / Can
Wood floor oil grey 1 l single container	HOPP00G0010001	1 l single container	40.80
Wood floor oil grey 1 l 6 pcs./box	HOPP00G0010006	1 l 6 pc./carton	216.00

## Wood floor soap

The mafi care products are cleaning and above all care in one! The mafi Wood floor soap has a very high fat content and therefore acts as a light oiling on the floor. The soap keeps the wood fibres smooth and flexible.

Dirt is bounded by the fat and can therefore be removed very easy. Regular maintenance with mafi Wood floor soap is vital for keeping the natural benefits of your mafi natural wood floor.



## Wood floor soap natural

DILUTION: 5 l warm water + 125 ml Wood Floor Soap.

Recommended Price, excl. VAT / GST

Product	Article Number	Dimension/Packaging unit	Eur / Can
Wood floor soap natural 1 l single container	HSPP00N0010001	1 l single container	21.60
Wood floor soap natural 1 l 6 pcs./box	HSPP00N0010006	1 l 6 pc./carton	108.00
Wood floor soap natural 2,5 l single container	HSPP00N0025001	2,5 l single container	38.40
Wood floor soap natural 2,5 l 4 pcs./box	HSPP00N0025004	2,5 l x 4 pc./carton	144.00
Wood floor soap natural 5 l single container	HSPP00N0050001	5 l single container	72.00
Wood floor soap natural 5 l 4 pcs./box	HSPP00N0050004	5 l x 4 pc./carton	266.40

## Wood floor soap white

DILUTION: 5 l warm water + 125 ml Wood Floor Soap.

Recommended Price, excl. VAT / GST

Product	Article Number	Dimension/Packaging unit	Eur / Can
Wood floor soap white 1 l single container	HSPP00W0010001	1 l single container	22.80
Wood floor soap white 1 l 6 pcs./box	HSPP00W0010006	1 l 6 pc./carton	112.80
Wood floor soap white 2,5 l single container	HSPP00W0025001	2,5 l single container	43.20
Wood floor soap white 2,5 l 4 pcs./box	HSPP00W0025004	2,5 l x 4 pc./carton	156.00
Wood floor soap white 5 l single container	HSPP00W0050001	5 l single container	74.40
Wood floor soap white 5 l 4 pcs./box	HSPP00W0050004	5 l x 4 pc./carton	283.20

## Wood floor soap grey

DILUTION: 5 l warm water + 125 ml Wood Floor Soap.

Recommended Price, excl. VAT / GST

Product	Article Number	Dimension/Packaging unit	Eur / Can
Wood floor soap grey 2,5 l single container	HSPP00G0025001	2,5 l single container	45.60
Wood floor soap grey 2,5 l 4 pcs./box	HSPP00G0025004	2,5 l x 4 pc./carton	170.40



## Balsam oil floor care

mafi care balm oil is emulsified oil in water and is ideally applied with a sheep's wool mop. Using a sheep's wool pad the floor can then be polished to produce a beautiful shine.

The floor is completely dry after about four hours. In addition to the glossy effect, the care oil balm is also used to revitalise floors.



## Balsam oil floor care natural

Gives dull floors a beautiful lustre when polished in.

Coverage per litre: approx. 20 m<sup>2</sup> (depending on the absorbability of the wood).

Recommended Price, excl. VAT / GST

Product	Article Number	Dimension/Packaging unit	Eur / Can
Balsam oil floor care natural 2,5 l single container	PBPP00N0025001	2,5 l single container	54.00
Balsam oil floor care natural 2,5 l x 4 pc./carton	PBPP00N0025004	2,5 l x 4 pc./carton	198.00

## Balsam oil floor care white

Gives dull floors a beautiful lustre when polished in.

Coverage per litre: approx. 20 m<sup>2</sup> (depending on the absorbability of the wood).

Recommended Price, excl. VAT / GST

Product	Article Number	Dimension/Packaging unit	Eur / Can
Balsam oil floor care white 2,5 l single container	PBPP00W0025001	2,5 l single container	60.00
Balsam oil floor care white 2,5 l x 4 pc./carton	PBPP00W0025004	2,5 l x 4 pc./carton	228.00

## Wood floor care set

The Care Set combines the Wooden Floor Soap with regular care and the Care Oil Balsam, to revitalise and polish the mafi Natural Wooden Floor. Also included are a dosage pump for the soap container and a spray bottle for the Care Oil Balsam. The sheeps wool hand pad is used for polishing. The mafi care slippers are made of sheeps wool and are a blessing for you and your floor.



## Wood floor care set natural

The perfect starter set for your mafi Natural Wooden Floor!

The Care Set combines the Wooden Floor Soap with regular care and the Care Oil Balsam, to revitalise and polish the mafi Natural Wooden Floor. Also included are a dosage pump for the soap container and a spray bottle for the Care Oil Balsam. The sheeps wool hand pad is used for polishing. The mafi care slippers are made of sheeps wool and are a blessing for you and your floor.

Recommended Price, excl. VAT / GST

Product	Article Number	Dimension/Packaging unit	Eur / Box
Wood floor care set natural	PSP00N0000001	1 carton	122.40

## Wood floor care set white

The perfect starter set for your mafi Natural Wooden Floor!

The Care Set combines the Wooden Floor Soap with regular care and the Care Oil Balsam, to revitalise and polish the mafi Natural Wooden Floor. Also included are a dosage pump for the soap container and a spray bottle for the Care Oil Balsam. The sheeps wool hand pad is used for polishing. The mafi care slippers are made of sheeps wool and are a blessing for you and your floor.

Recommended Price, excl. VAT / GST

Product	Article Number	Dimension/Packaging unit	Eur / Box
Wood floor care set white	PSP00W0000001	1 carton	124.80

## Trouble Shooter Set

The Trouble Shooter Set is the ideal starter kit for maintaining the value of your mafi natural wood floor.

Content:

- 1x Spot Stop ® Grease Stain Remover- spray can
- 1x Anti Grey Deep Cleaner
- 1x Mop cloth
- 2 Stk. Sheepwool Pad for handpad
- 2 Stk. Polishing Fleece white for handpad
- 1x Dirt eraser
- 1x Polishing pad
- 1x Information leaflet
- 1x Care & Maintenance manual



Recommended Price, excl. VAT / GST

Product	Article Number	Dimension/Packaging unit	Eur / Box
Trouble Shooter Set	TSP00N0000001	1 carton	69.00

## Exclusively for processing by professionals

### Professional oil

For commercial use (oil with solvent component – this enables quicker handling), oxidative drying.

[Fast-curing]

- Coverage per litre: approx. 8 - 10 m<sup>2</sup> for 2 applications on untreated wood.
- Coverage per litre: approx. 40 - 80 m<sup>2</sup> (depending on the absorbability of the wood) when treating previously oiled floors.



### Professional oil natural

For commercial use (oil with solvent component – this enables quicker handling), oxidative drying.

Recommended Price, excl. VAT / GST

Product	Article Number	Dimension/Packaging unit	Eur / Can
Professional oil natural 5 l single container	POPP00N0050001	5 l single container	138.00
Professional oil natural 5 l 4 pcs./box	POPP00N0050004	5 l x 4 pc./carton	528.00

### Professional oil white

For commercial use (oil with solvent component – this enables quicker handling), oxidative drying.

Recommended Price, excl. VAT / GST

Product	Article Number	Dimension/Packaging unit	Eur / Can
Professional oil white 5 l single container	POPP00W0050001	5 l single container	162.00
Professional oil white 5 l 4 pcs./box	POPP00W0050004	5 l x 4 pc./carton	636.00

# Wood Lye

[Dangerous good]

Wood lye is a dangerous substance according to transport regulations. Special shipping requirements will be needed.



# Wood Lye transparent

[Dangerous good]

Recommended Price, excl. VAT / GST

Product	Article Number	Dimension/Packaging unit	Eur / Can
Wood Lye transparent 2,5 l single container	HLPP00N0025001	2,5 l single container	38.40
Wood Lye transparent 2,5 l 4 pcs./box	HLPP00N0025004	2,5 l x 4 pc./carton	136.80

# Wood Lye white

[Dangerous good]

Recommended Price, excl. VAT / GST

Product	Article Number	Dimension/Packaging unit	Eur / Can
Wood Lye white 2,5 l single container	HLPP00W0025001	2,5 l single container	39.60
Wood Lye white 2,5 l 4 pcs./box	HLPP00W0025004	2,5 l x 4 pc./carton	139.20

# Super Cleaner

For badly soiled areas on oiled wood surfaces. ph value = 9,5 – 9,7  
 COVERAGE: approx. 20 – 50 m<sup>2</sup> (depending on soiling)

## INSTRUCION FOR USE

1. Mix approx. ½ litre Super Cleaner with 10 litre warm water.
2. Apply we using mop (or similar), leave to soak in for a short time and then treat the soiled surface using green sanding fleece (by hand or machine). Do not use a green pad for Vulcano floors as scratch marks can become visible. **IMPORTANT:** Always treat only small areas, max. 10 – 15 m<sup>2</sup>, at a time. Remove the solution containing the dirt immediately with clear water (always work with two buckets!). Repeat this procedure if necessary.
3. Wipe again with clear water; no Super Cleaner solution should be left on the wood surface.
4. After the wood surface has been allowed to dry out completely, re-oil must be carried out using mafi Wood Floor Oil or mafi Prof Oil.



Recommended Price, excl. VAT / GST

Product	Article Number	Dimension/Packaging unit	Eur / Can
Super Cleaner 1 l single container	SRPP00N0010001	1 l single container	21.60
Super Cleaner 1 l 6 pcs./box	SRPP00N0010006	1 l 6 pc./carton	112.80

# Anti Grey Deep Cleaner

The mafi Anti Grey Deep Cleaner serves for the removal of different stains such as pet urine, oxidation traces, edges from flowerpots and similar, dark areas, and as additional aid for removal of old red wine stains and joint compound remains.

The affected area is first moistened with water. Then the Anti Grey Deep Cleaner is applied with a small paint brush, allowed to soak for a short time and then washed off with water in combination with mafi Wood Floor Soap. The process can be repeated several times.

**ATTENTION:** The Anti Grey Deep Cleaner bleaches the wood – therefore the soaking time should not be too long and all traces must be removed afterwards. The result is only visible once completely dry. A decision on a re-application should only be made on the basis of the visible wood colour thereafter.



Recommended Price, excl. VAT / GST

Product	Article Number	Dimension/Packaging unit	Eur / Can
Anti Grey Deep Cleaner	FEPP00N0250001	250ml bottle	14.40

# Spot Stop ® Grease Stain Remover

The mafi Spot Stop quickly and easily removes fat stains from mafi Natural Wood Floors. [Dangerous good]

## Instructions:

1. Warm the fat stain briefly with a hairdryer - this re-liquifies the fat.
2. Spray the stain from about 20 cm away.
3. Allow to work for three minutes.
4. Then, wash the area with warm water and the relevant mafi wood floor soap (do not scrub!)
5. Once the area is dry, check to see if the stain has disappeared. Repeat the process if necessary.



Recommended Price, excl. VAT / GST

Product	Article Number	Dimension/Packaging unit	Eur / Can
Spot Stop ® Grease Stain Remover- spray can	SSPP00N0150001	150 ml	18.00

## Mechanical surface treatment

### Single-disk machine Cleanfix PE 300 Floor Mac

With disk drive for use in privately used zones.

Particularly suitable for cleaning and polishing – also for use on staircases.

Technical data: 500 Watt · Oscillation: 1.450 pro min. · Weight: 13 kg

Delivery time: On request! Separate dispatch: Delivery by parcel service.



Recommended Price, excl. VAT / GST

Product	Article Number	Dimension/Packaging unit	Eur / pcs.
Single-disk machine Cleanfix PE 300 Floor Mac	MAPZ3301450500	330 mm diameter	948.00

## Sanding fleece green for machine



Use to work in oil (not suitable for Vulcano floors).

Recommended Price, excl. VAT / GST

Product	Article Number	Dimension/Packaging unit	Eur / pcs.
Sanding/Polishing Fleece green 406 mm	SGPZ0000406001	406 mm (approx. 1 cm thickness)	10.20
Sanding/Polishing Fleece green 406 mm 10 pc./carton	SGPZ0000406010	406 mm approx. 1 cm thickness) 10 pc./carton	83.40
Sanding/Polishing Fleece green 330 mm	SGPZ0000330001	330 mm (approx. 1 cm thickness)	7.80
Sanding/Polishing Fleece green 330 mm 10 pc./carton	SGPZ0000330010	330 mm (approx. 1 cm thickness) 10 pc./carton	57.60

## Polishing fleece white for machine



Use for polishing with oil.

Recommended Price, excl. VAT / GST

Product	Article Number	Dimension/Packaging unit	Eur / pcs.
Sanding/Polishing Fleece white 406 mm	SWPZ0000406001	406 mm (approx. 2 cm thickness)	21.60
Sanding/Polishing Fleece white 406 mm 5 pcs./box	SWPZ0000406005	406 mm (approx. 2 cm thickness) 5 pc./carton	96.00
Sanding/Polishing Fleece white 330 mm	SWPZ0000330001	330 mm (approx. 2 cm thickness)	16.20
Sanding/Polishing Fleece white 330 mm 5 pcs./box	SWPZ0000330005	330 mm (approx. 2 cm thickness) 5 pc./carton	72.00

## Sheepwool pad for machine



Use to polish floors treated with oil or soap – for a beautiful silky finish.

Recommended Price, excl. VAT / GST

Product	Article Number	Dimension/Packaging unit	Eur / pcs.
Sheepwool Pad 406 mm	SSPZ0000406001	406 mm (approx. 1 cm thickness)	10.80
Sheepwool Pad 406 mm 10 pc./carton	SSPZ0000406010	406 mm (approx. 1 cm thickness) 10 pc./carton	96.00
Sheepwool Pad 330 mm	SSPZ0000330001	330 mm (approx. 1 cm thickness)	10.20
Sheepwool Pad 330 mm 10 pc./carton	SSPZ0000330010	330 mm (approx. 1 cm thickness) 10 pc./carton	88.80

# Mechanical surface treatment

## Handpad Handle



Suitable for:

- Sanding fleece green for portable and orbital sander
- Polishing fleece white for portable and orbital sander
- Sheepwool pad for portable and orbital sander

Recommended Price, excl. VAT / GST

Product	Article Number	Dimension/Packaging unit	Eur / pcs.
Handpad Handle	RHPZ000000001	280 x 150 mm	34.20

## Sanding fleece green for handpad



Use to work in oil (not suitable for Vulcano floors). Dimension: 280 x 150 mm

Recommended Price, excl. VAT / GST

Product	Article Number	Dimension/Packaging unit	Eur / pcs.
Sanding/Polishing Fleece green handpad	SGPZ000HAND001	280 x 150 mm	4.20
Sanding/Polishing Fleece green for handpad 25 pcs./ box	SGPZ000HAND025	280 x 150 mm 25 pc./carton	73.20

## Polishing fleece white for handpad



Use for polishing with oil. Dimension: 280 x 150 mm

Recommended Price, excl. VAT / GST

Product	Article Number	Dimension/Packaging unit	Eur / pcs.
Polishing Fleece white for handpad	SWPZ000HAND001	280 x 150 mm	4.20
Polishing Fleece white for handpad 25 pcs./box	SWPZ000HAND025	280 x 150 mm 25 pc./carton	78.00

## Sheepwool pad for handpad



Use to polish floors treated with oil or soap – for a beautiful silky finish. Dimension: 280 x 150 mm

Recommended Price, excl. VAT / GST

Product	Article Number	Dimension/Packaging unit	Eur / pcs.
Sheepwool Pad for handpad	SSPZ000HAND001	280 x 150 mm	6.60
Sheepwool Pad for handpad 10 pcs./box	SSPZ000HAND010	280 x 150 mm 10 pc./carton	52.80



## Roller for Oil or Lye

With long handle.  
Dimension: 250 mm



Recommended Price, excl. VAT / GST

Product	Article Number	Dimension/Packaging unit	Eur / pcs.
Roller for Oil or Lye	ROPZ0000000001	250 mm	21.60
Replacement Roller for Oil or Lye Roller	REPZ0000000001	250 mm	11.30

## Foam Rubber wiper

For applying Balsam Oil on the floor.



Recommended Price, excl. VAT / GST

Product	Article Number	Dimension/Packaging unit	Eur / pcs.
Foam Rubber wiper	MGPZ0000001	450 mm	9.20

## Spray

For local application of concentrated Wood Floor Soap and water mixture.



Recommended Price, excl. VAT / GST

Product	Article Number	Dimension/Packaging unit	Eur / pcs.
Spray bottle	SFPZ0000000000	0,5 l	14.40

## Dosage Pump

AREA OF APPLICATION: For 2.5 or 5 litre container.



Recommended Price, excl. VAT / GST

Product	Article Number	Dimension/Packaging unit	Eur / pcs.
Dosage Pump 2,5 l	DPPZ0000025001	2,5 l pc.	18.00
Dosage Pump 5 l	DPPZ0000050001	5 l pc.	18.00

# Wiping systems

## mafi Set Ultraspeed Pro

Dimension Trolley total: 560 x 380 x 900 mm  
Length Stick: 1000 - 1800 mm

The complete wet flat wiper system Ultraspeed is a successful symbiosis between intensive cleaning and a powerful press. Perfectly suitable for big areas or commercial projects.

The set includes:

- mafi Ultraspeed Pro Mop Holder (40 cm)
- mafi Ultraspeed Pro Telescopic Stick (100 - 180 cm)
- mafi Ultraspeed Pro Double-Bucket Trolley (1 x 10 l + 1 x 25 l) and press
- mafi Ultraspeed Pro Mop (Cotton)



Recommended Price, excl. VAT / GST

Product	Article Number	Dimension/Packaging unit	Eur / pcs.
mafi Ultraspeed Pro Set	VIPZULTRASETPRO	560 x 380 x 900 mm	228.00

## mafi Ultraspeed Pro Double-Bucket Trolley

suitable for mafi Set Ultraspeed Pro:

Two buckets one with 25 l and one with 10 l including roller and press



Recommended Price, excl. VAT / GST

Product	Article Number	Dimension/Packaging unit	Eur / pcs.
mafi Ultraspeed Pro DoubleBucket-Trolley with Press	VIPZULTRAPRO147209	1 x 10 l + 1 x 25 l	204.00

## mafi Ultraspeed Pro Spare-Bucket

suitable for mafi Set Ultraspeed Pro:

One bucket with 10 l or one bucket with 25 l



Recommended Price, excl. VAT / GST

Product	Article Number	Dimension/Packaging unit	Eur / pcs.
mafi Ultraspeed Pro Bucket 10 l	VIPZULTRA147250	1 pc. 10 l	36.00
mafi Ultraspeed Pro Bucket 25 l	VIPZULTRA114002	1 pc. 25 l	36.00

## mafi Ultraspeed Pro Press

suitable for mafi Set Ultraspeed Pro.



Recommended Price, excl. VAT / GST

Product	Article Number	Dimension/Packaging unit	Eur / pcs.
mafi Ultraspeed Pro Press	VIPZULTRA113972	1 pc.	62.40

## mafi Ultraspeed Pro Telescopic Stick

suitable for mafi Set Ultraspeed Pro:  
mafi Ultraspeed Telescopic Stick to combine with mafi Ultraspeed Mop Holder



Recommended Price, excl. VAT / GST

Product	Article Number	Dimension/Packaging unit	Eur / pcs.
mafi Ultraspeed Pro Telescopic Stick	VIPZULTRA111380	1 pc. 1000 - 1800 mm	30.00

## Spraymop Stick

Stainless steel mop handle with integrated spray system - also suitable for our Set Ultraspeed Pro.

Capacity: 350ml sufficient for up to 75m<sup>2</sup>

The mop handle with an integrated spray system is the perfect choice for quick and easy cleaning of mafi natural wood floors. The mop is made of high-quality stainless steel and has a spray system that applies the wood floor soap directly to the floor while you mop.

Thanks to the integrated spray system, there is no need to use an extra bucket of water and wood floor soap. Instead, simply fill the mop directly with a mixture of soap and water. Then squeeze the handle to activate the soapy water and spray it onto the floor. Mop holder, pocket mop and soap are not included.



Recommended Price, excl. VAT / GST

Product	Article Number	Dimension/Packaging unit	Eur / pcs.
Spraymop Stick	VIPZSPRAY151514	145 cm	74.40

## mafi Ultraspeed Pro Mop Holder

suitable for mafi Set Ultraspeed Pro:  
mafi Ultraspeed Mop Holder to combine with mafi Ultraspeed Telescopic Stick



Recommended Price, excl. VAT / GST

Product	Article Number	Dimension/Packaging unit	Eur / pcs.
mafi Ultraspeed Pro Mop Holder	VIPZULTRA113970	40 cm	30.00

## mafi Ultraspeed Pro Mop (Cotton)

suitable for mafi Set Ultraspeed Pro:  
mafi Ultraspeed Mop Cotton



Recommended Price, excl. VAT / GST

Product	Article Number	Dimension/Packaging unit	Eur / pcs.
mafi Ultraspeed Pro Mop (Cotton)	VIPZULTRA128660	40 cm	16.80

## Mop „Cotton“

Cotton mop with patented wring-out function.



Recommended Price, excl. VAT / GST

Product	Article Number	Dimension/Packaging unit	Eur / Box
Mop Cotton	WMPZCOTTON0001	143 mm	48.00
Mop Cotton 5 pc. / carton	WMPZCOTTON0005	143 mm 5 pc./carton	192.00
Replacement mop	WMPZCOTERS0001	1 pc.	24.00

## Pocket Mop Cotton

Universal Cotton Mop - also matches Set Ultraspeed Pro.



Recommended Price, excl. VAT / GST

Product	Article Number	Dimension/Packaging unit	Eur / pcs.
Pocket Mop Cotton	VIPZTASCH102724	40 cm	14.40

# Felt collection

## Felt Slippers

European size table:

S = 36 - 38

M = 39 - 40

L = 41 - 44

XL = 45 - 48



Recommended Price, excl. VAT / GST

Product	Article Number	Dimension/Packaging unit	Eur / pcs.
Felt Slippers - S	FPPZ000000S000		23.40
Felt Slippers - M	FPPZ000000M000		23.40
Felt Slippers - L	FPPZ000000L000		23.40
Felt Slippers - XLarge	FPPZ000000XL000		23.40

## Felt Overshoe



Recommended Price, excl. VAT / GST

Product	Article Number	Dimension/Packaging unit	Eur / pcs.
Felt Overshoe	FPPZ000XXXL000		28.20

## Slippers "Wüdara"

European size table:

S = 36 - 38

M = 39 - 40

L = 41 - 44

XL = 45 - 48



Recommended Price, excl. VAT / GST

Product	Article Number	Dimension/Packaging unit	Eur / pcs.
Filz Pantoffel - Wüdara S	FPPZWUD000S000		31.20
Felt Slippers - Wüdara M	FPPZWUD000M000		31.20
Felt Slippers - Wüdara L	FPPZWUD000L000		31.20
Felt Slippers - Wüdara XLarge	FPPZWUD00XL000		34.80

# Product specific instructions

## Lye treated surfaces

For surfaces with lye treatments, large colour differences can arise between the individual planks. These harmonise over time and the regular care with the mafi wood floor soap.

## Vulcano Floors

The noble, brown coloring of the Vulcano is achieved by a special thermo treatment (high-temperature wood drying process) without any chemical additives, using only heat and water. This process reduces swelling and shrinkage as well as internal stresses, increasing the wood's resistance to fungus and pests. Additionally, the dimensional stability is enhanced. Since the floor remains perfectly natural, it is important to protect it from strong UV rays to prevent lightening. Despite the thermo treatment, color differences remain in the wood and become more intense due to the dark tones.

## Metal on Wood

Especially with Oak floors, the tannic acid in the wood can react with metal and cause black spots (oxidation). To counteract this effect and also reduce scratches, we recommend using felt pads under tables, chair legs, etc. Use white or beige felt pads as coloured felts rub off. Additionally, flower pots should not be placed directly on the floor, as moisture between the wood and the pot cannot dry out, leading to the formation of mold. Oxidation stains can usually be removed with mafi Anti Grey Deep Cleaner.

## Domino

The mafi Domino collection is not pre-oiled during production and must be oiled after installation on-site. Therefore, mafi Domino floors can only be ordered in their raw state. The final appearance can be achieved by applying the appropriate mafi wood floor oils. It's important to follow the mafi installation instructions carefully for best results.

## Packaging

mafi natural wood floors are packed in packages with multiple planks. Packages with floors of 16 mm thickness contain six planks, for planks wider than 240 mm the packages include four planks. Packages with floors of 19 mm thickness contain four planks. Thin planks are packed with nine planks per package. Domino floors with a thickness of 19 mm contain 10 pieces per package. In general, only whole planks are delivered, which can lead to slight deviations from the square meters ordered. There may be up to a maximum of 3 % surplus material delivered or invoiced. When ordering fixed lengths, a maximum of 2 % of the ordered quantity may differ from the ordered fixed length.

## Glue

The solid wood layers of mafi natural wood floors are bonded exclusively with PVAc (white glue). This adhesive is composed of water, coal, chalk, and acetic acid, and it does not contain solvents that could potentially trigger allergic reactions. Importantly, mafi does not use any substances containing formaldehyde. As a result, our floors can be classified under the E1 classification according to ÖNORM EN 14342 standards. This classification indicates low emissions of formaldehyde, making mafi natural wood floors a healthier and environmentally-friendly choice for indoor spaces.

# FAQ

## Where are mafi natural wood floors produced?

mafi natural wood floors are manufactured exclusively in Austria. In two production facilities, within 12 km of each other, the entire production chain, from raw material to the finished planks is kept in-house. Any external service providers such as sawmills come from the local region. Short distances, close cooperation and transparency are a guarantee of product quality.

## How are mafi planks constructed?

The majority of mafi planks are made of balanced, symmetrical 3-layer construction. Thus, the top and also the back layers are made with the wood and same thermal treatment. This results in a balanced counter-move, making the planks significantly stiffer and, therefore, perfectly suitable for installation on underfloor heating. The middle layer is cross-glued and consists of Austrian Spruce.

The panel parquet is a symmetrical 3-layer construction with circumferential chamfer and an all-around tongue and groove for endless laying. Top layer, approx. 4 mm, consisting of quality select wood. Middle layer consisting of a 3-layer panel; white glue (PVAc) is used to stick it to the top and back layers. Back layer, approx. 4 mm, consisting of the same wood as the top layer.

The thin plank is produced in a multi layer construction. The top layer is 4 mm thick, whereas the back layer is approx. 3 mm thick. Both layers are made of the same wood with the same thermal treatment. For the middle layer, a softwood is used crossways and the top layer as well as the back layer are glued with White Glue (PVAc).

Floors of the mafi Domino collection are made from massive grain-block wood cubes, which are delivered on a bonded floor net in the size 400 x 200 mm.

## Can I customize a mafi natural wood floor?

mafi produces to order and thus enables individual customizations of the products. A variant described already in the price list is the free choice of the putty filler colour. Products that are marked with CC (custom colour) can be made in an appropriate RAL colour. Also the Carving collection offers potential for individual designs. Sample production and quantities are to be discussed prior to production. Special thicknesses, special surface treatments or further adjustments are available on request.

## Where can I find technical information about the wood floor?

Information regarding underfloor heating suitability, application areas, emission classes, fire behaviour and weight can be found in the footer of the corresponding price list page. You can download the product data sheet for each individual floor on the product detail page on mafi.com. Information on accessories and care products can be found in the information of the product description.

## How do the floors get their colors?

mafi completely dispenses with lacquer or other film-forming surface treatments and relies purely on natural oils as well as a chemical-free thermo treatment. The colours of the planks are always based on the colour play of nature. Optionally, the wood is also thermally dried which results in a colour change from light to dark. The choice of the oil colour completes the finishing. In short, the wood + thermo treatment (yes/no/intensity) + oil = colour tone of the plank.

## Why are there differences in the same surfaces on different products?

The natural growth of each tree is unique and individual. Factors such as grain pattern, pore size, and knot appearance determine the final nuances of the planks. Therefore, slight variations can occur between products like Oak Character and Oak Country, even with the same surface treatment. These natural variations contribute to the unique charm of natural wood floors.

## Why are not all product surfaces shown in the color collection overview?

In the color overview of each collection, we're primarily focussed on a quick overview of the various color versions of the products. Possible machining treatments of the surface such as „heavily brushed“ have almost no influence on the resulting color. Therefore, an individual wood pattern sample is avoided in these cases.

# FAQ

## What information is required for a mafi offer?

For a quote or order, we require a detailed product description. For floors, this includes the product type, chosen surface finish, and specific dimensions (length, width, thickness). Alternatively, you can provide the entire product code. Additionally, we need information on quantity, desired delivery timeframe, and a shipping address if different from the billing address.

## How do I place an order?

Orders must be in writing. We accept orders by email or letter. In addition, mafi partners can order around the clock on mafi.com. Your responsible internal and external sales contact is happy to assist you.

## How does a complete article code look like?

A complete article code contains details about the desired product, including its surface, dimensions, and, if applicable, a profile (e.g., for skirting boards). The grid system on each price list page indicates the specific information required.

## What do the coloured dots next to the products mean?

The system indicates the production time for products using colored dots. A Green Dot means a production time of 4 days, while a Yellow Dot indicates a production time of 10 days. A Red Dot requires a specific request, which doesn't always imply a lengthy production time. Orders exceeding 300 m<sup>2</sup> automatically receive a Red Dot.

## Do I need to calculate the possible surcharges manually?

The mafi online ordering system for partners automatically calculates surcharges for you. By switching between consulting and ordering modes, you can also view your margin - also in relation to an offer generated within the system.

## Where can I find information about packing sizes and weight?

Packages of 16 mm thick flooring contain six planks, except for planks wider than 245 mm, which come in packages of four. Packages of 19 mm thick flooring contain four planks. Thin planks are packed nine per package. Domino floors with a thickness of 19 mm contain ten pieces per package. For weight per square meter, please refer to the respective price sheet. Information on care and accessories can also be found on the corresponding price sheets.

## How can I order samples?

For sample orders, please get in touch with your internal sales representative. If you don't have a regular contact at mafi, you can contact your external sales representative. You can also call us at +43 7746 2711 or email us at muster@mafi.com. Additionally, mafi Sales Partners can use our online sample ordering service, which is available 24/7.

## How can I order personalized samples?

For certified mafi Sales Partners, we offer personalised samples marked with the partner's logo and contact details. This service is available exclusively through our online order form. Email orders will continue to be processed with regular samples.

## What should I keep in mind when handling samples?

Samples are individual sections of planks and represent only a part of the whole floor. The mafi catalog and our website should also be used for a thorough consultation. Samples should be regularly checked and, if necessary, maintained or re-oiled.



# FAQ

## What options does mafi offer for showrooms?

mafi offers partners a complete showroom corporate identity planning service. Options include interchangeable modules for sample boards, starter sets like the Pioneer Sample Stand and colored frames for wall-mounted sample boards. You can find all available options in the mafi POS folder.

## What sales support products does mafi offer?

In addition to the current catalog and website, new print and digital materials are constantly being developed to support the consultation process. The mafi POS folder contains details on all available marketing materials.

## What are the best ways to get more information beyond the price list?

The most thorough and detailed method is to consult with a mafi partner or external sales contact in your region. Our website is ideal for obtaining advanced information and conducting research. The PDF version of the price list provides direct links to each relevant product on the website through the color overview.

## What is the mafi passport?

The mafi passport is handed over with the delivery note and applies to products listed in the current price list. No mafi passport is provided for custom-made products. This passport includes care instructions for the end customer and features a registration code for them to register their floor on mafi.com. Additionally, a small Welcome Package will be delivered as a token of appreciation. For Partners, there is a tear-off card on the passport to confirm the handover of care instructions.

## How do I get pictures from mafi?

The wood sample images featured in the price list and the reference images are accessible to our partners on our website. Using the „Planning Table“ tool on mafi.com, partners can download these images in high-resolution quality. However, please note that image rights must be approved for use, and access to the Planning Table requires activation by your mafi external sales contact.

## How are mafi floors installed?

An overview of the most essential aspects of installation can be found at the start of this pricelist. For more detailed information, please refer to the mafi Installation Instructions and our website mafi.com.

## How should mafi floors be maintained?

An initial description can be found at the start of this pricelist. For more detailed information, please refer to the mafi Care Instructions and our website mafi.com.

## How do I find my mafi contact person?

At mafi there is a duo consisting of both an external and an internal sales contact available for you. We will connect you to your relevant contact person if not already established. You can reach us at +43 7746 2711 or office@mafi.com.

## How can I become a Sales Partner?

We are always interested in expanding or improving our existing Sales Partner Network. Your responsible external sales contact will be happy to discuss possible co-operations, chances and conditions for collaboration. If you don't already have a contact, we will gladly help. You can reach us at +43 7746 2711 or office@mafi.com.



**mafi.com**

mafi Naturholzboden GmbH · Utzweihstraße 25 · A - 5212 Schneegattern · +43 [0]7746 2711 · office@mafi.com · www.mafi.com