

OUT DOORS

ORGANIZER **2.0**

01

08 SKE 2.0 CEMENTO // **CONCRETE**
14_TERRA CREA
24_PRIMA MATERIA

02

30 SKE 2.0 LEGNO // **WOOD**
38_ESSENCE
40_LES BOIS
48_WOOD SIDE

03

52 SKE 2.0 PIETRA // **STONE**
58_NATIVA
66_PIASENTINA
68_EVOLUTION DU KRONOS
74_LE REVERSE
82_CARRIERE DU KRONOS
88_ROCKS

04

92 CARATTERISTICHE TECNICHE
TECHNICAL CHARACTERISTICS

99 GAMMA PRODOTTI
RANGE

102 INDICAZIONI DI POSA
LAYING INSTRUCTION

dedicato all'OUTDOOR to the OUTDOOR



SKE2.0

SKE due centimetri MONOLITICO PER ESTERNI

**E COMPLEMENTI
PER LA PROGETTAZIONE**

2CM thick outdoor porcelain

**SLABS WITH COSTUMIZED
TRIMS FOR PROJECTS**

KRONOS PRESENTA
UNA SELEZIONE DI CEMENTI
PIETRE E LEGNI CERAMICI
IN GRES PORCELLANATO
DEDICATI IN PARTICOLARE
ALL'OUTDOOR.
SONO PAVIMENTI
CON **SPESSORE 2 CM** E
PEZZI SPECIALI PROGETTATI
PER GARANTIRE PRATICITÀ,
RESISTENZA E UN'ALTA
RESA ESTETICA
ALL'ARREDO ESTERNO,
MA NON SOLO;
SCALE, BORDI PISCINA.

KRONOS 2CM
THICK OUTDOOR
PORCELAIN SLABS
ARE AVAILABLE
IN CONCRETE,
WOOD AND STONE
EFFECT. THEY
GUARANTEE
ELEGANCE,
PRACTICALITY
AND RESISTANCE
TO ALL OUTDOOR
SPACES INCLUDING
STAIRS AND POOL
EDGES.

due centimetri

MONOLITICO PER ESTERNI

CONCRETE

SKE2.0

TERRA CREA



CALCE 2.0



CORDA 2.0

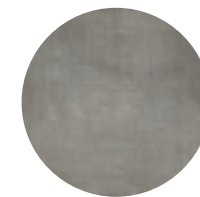

LIMO 2.0

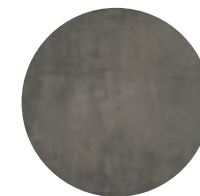

POMICE 2.0



MATTONE 2.0

PRIMA MATERIA



CEMENTO 2.0



CENERE 2.0

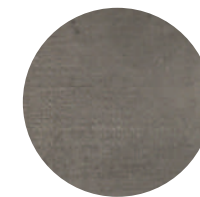

SANDALO 2.0



floor
60x60
CEMENTO 2.0

wall
29x120
CEMENTO SUNSET 3D

pool edges
SANDALO

elevata resa estetica

high aesthetic performance



floor
80x80
CENERE 2.0

wall
29x120
LES BOIS BOCOTE BAGUETTE 3D



TERRA CREA

CALCE



MODERATA VARIAZIONE
MODERATE VARIATION

floor 60x120 CALCE 2.0 | 20,2x20,2 - 20,x30,4 BLOCK CALCE 2.0



TE051 CALCE 2.0
60x120 - 24"x48"

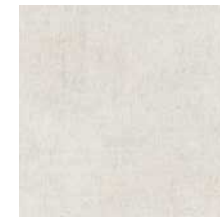

TE056 CALCE 2.0
80x80 - 32"x32"



TE046 CALCE 2.0
60x60 - 24"x24"

BLOCK2.0



TE041 CALCE 2.0
20,2x30,4 - 8"x12"



TE036 CALCE 2.0
20,2x20,2 - 8"x8"



TERRA CREA

CORDA



MODERATA VARIAZIONE
MODERATE VARIATION

floor 60x60 CORDA 2.0



TE053 CORDA 2.0
60x120 - 24"x48"



TE058 CORDA 2.0
80x80 - 32"x32"



TE048 CORDA 2.0
60x60 - 24"x24"

BLOCK2.0



TE043 CORDA 2.0
20,2x30,4 - 8"x12"



TE038 CORDA 2.0
20,2x20,2 - 8"x8"



TERRA CREA

LIMO



MODERATA VARIAZIONE
MODERATE VARIATION

floor 20x120 LES BOIS SLAVONIA **wall** 7,5x30 - 7,5x15 LIMO SPAKKO **platform and flower planter** LIMO 2.0

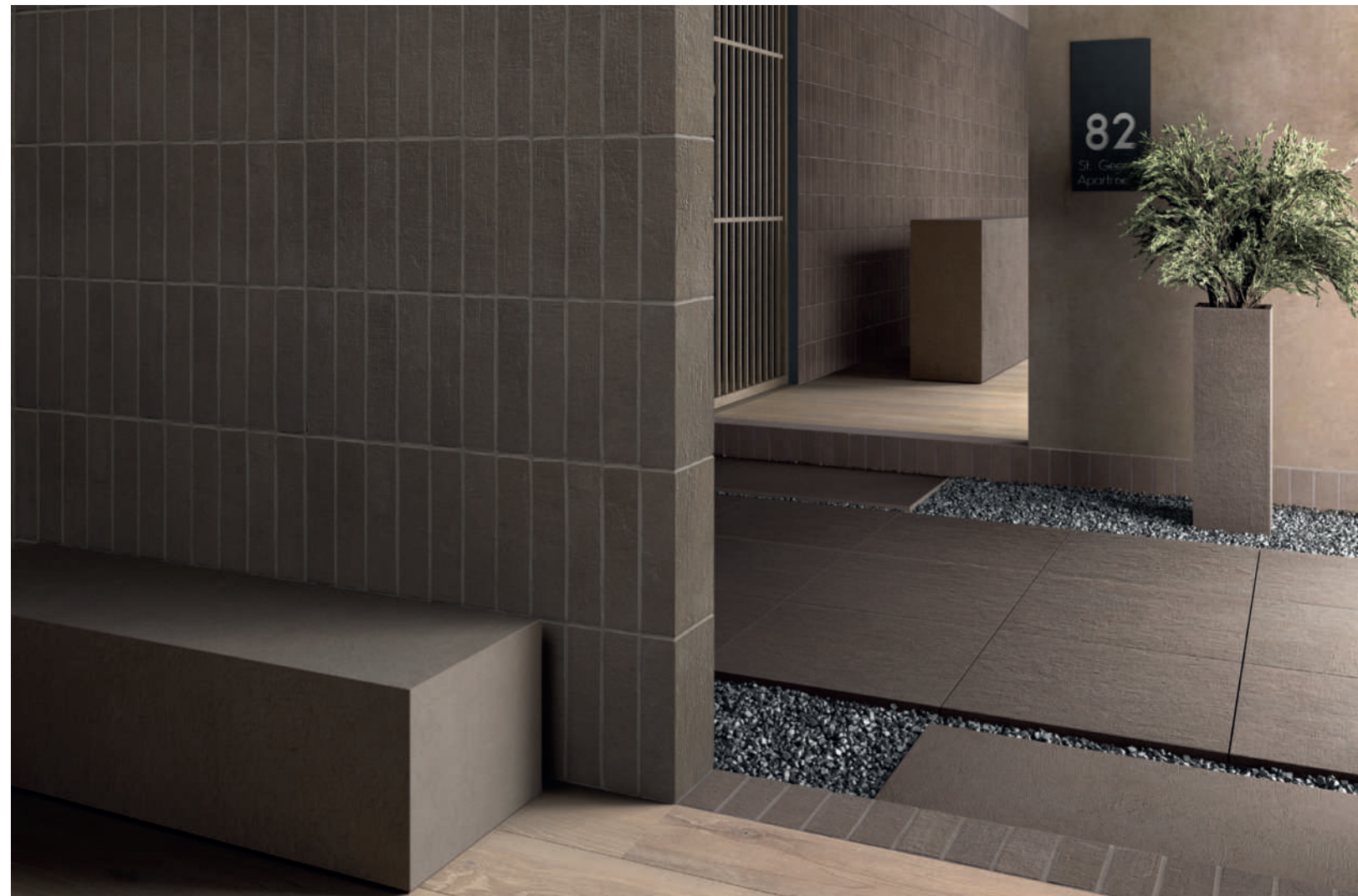

TE052 LIMO 2.0
60x120 - 24"x48"



TE057 LIMO 2.0
80x80 - 32"x32"



TE047 LIMO 2.0
60x60 - 24"x24"

BLOCK2.0



TE042 LIMO 2.0
20,2x30,4 - 8"x12"



TE037 LIMO 2.0
20,2x20,2 - 8"x8"



TERRA CREA

POMICE



MODERATA VARIAZIONE
MODERATE VARIATION

floor 20,2x30,4 POMICE BLOCK **wall** 80x180 LES BOIS COBOLO **stairs,walkway & flower planters** POMICE 2.0



TE055 POMICE 2.0
60x120 - 24"x48"



TE060 POMICE 2.0
80x80 - 32"x32"



TE050 POMICE 2.0
60x60 - 24"x24"

BLOCK2.0



TE045 POMICE 2.0
20,2x30,4 - 8"x12"



TE040 POMICE 2.0
20,2x20,2 - 8"x8"



TERRA CREA

MATTONE



MODERATA VARIAZIONE
MODERATE VARIATION

floor 60x120 MATTONE 2.0 **wall** 120x280 CORDA **counter** 3,2x20 MATTONE MOSAICO



TE054 MATTONE 2.0
60x120 - 24"x48"

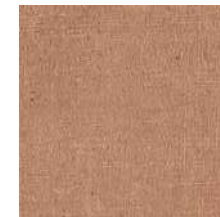

TE059 MATTONE 2.0
80x80 - 32"x32"



TE049 MATTONE 2.0
60x60 - 24"x24"

BLOCK2.0



TE044 MATTONE2.0
20,2x30,4 - 8"x12"



TE039 MATTONE 2.0
20,2x20,2 - 8"x8"

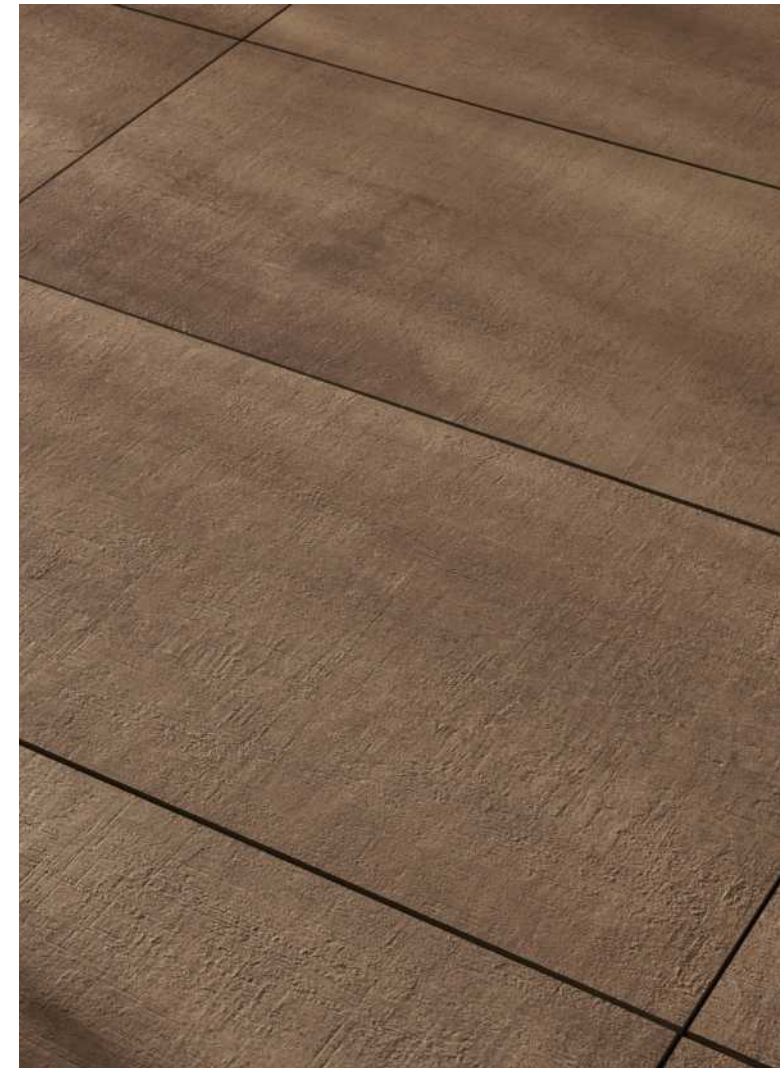

PRIMA MATERIA

CEMENTO



LIEVE VARIAZIONE
SLIGHT VARIATION

floor 80x80 CEMENTO 2.0



8038 CEMENTO 2.0
80x180 - 32"x72"



8095 CEMENTO 2.0
40x120 - 16"x48"



8090 CEMENTO 2.0
20x120 - 8"x48"



8075 CEMENTO 2.0
80x80 - 32"x32"



8062 CEMENTO 2.0
60x60 - 24"x24"



PRIMA MATERIA

CENERE



LIEVE VARIAZIONE
SLIGHT VARIATION

floor, wall and stairs 40x120 CENERE 2.0

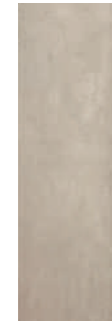

8096 CENERE 2.0
40x120 - 16"x48"



8091 CENERE 2.0
20x120 - 8"x48"

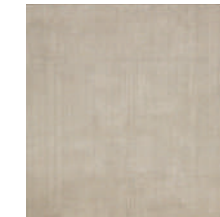

8076 CENERE 2.0
80x80 - 32"x32"



8063 CENERE 2.0
60x60 - 24"x24"



PRIMA MATERIA

SANDALO



V2
LIEVE VARIAZIONE
SLIGHT VARIATION

floor 60x60 SANDALO 2.0 **wall** 29x120 SANDALO SUNSET 3D

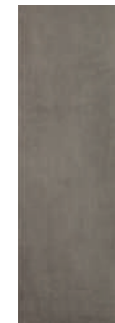

8098 SANDALO 2.0
40x120 - 16"x48"



8093 SANDALO 2.0
20x120 - 8"x48"



8077 SANDALO 2.0
80x80 - 32"x32"



8064 SANDALO 2.0
60x60 - 24"x24"



due centimetri

MONOLITICO PER ESTERNI

WOOD

SKE2.0

FINITURA **LEGNO** / WOOD EFFECT

31

ESSENCE



PURE DECK 2.0

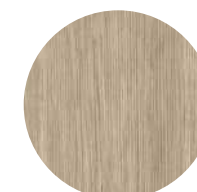

AMBRE DECK 2.0



MUSK DECK 2.0

LES BOIS



COBOLO 2.0



SLAVONIA 2.0



SARAWA 2.0



MIX DARK CHEVRY 2.0



SLAVONIA CHEVRY 2.0



SARAWA CHEVRY 2.0

WOOD SIDE



NUT 2.0



OAK 2.0



wall
30x240
NUT 2.0
floor
60x60
BRUGES 2.0



floor
40x120
OAK DOGA 2.0

pavimenti inalterati nel tempo

highly durable
outdoor floors

floor
20x120
OAK 2.0



ESSENCE

PURE DECK
AMBRE DECK
MUSK DECK



V2

LIEVE VARIAZIONE
SLIGHT VARIATION

floor 26,5x180 AMBRE DECK 2.0



ES060 PURE DECK
26,5x180 - 10½"x72"



ES061 AMBRE DECK
26,5x180 - 10½"x72"



ES062 MUSK DECK
26,5x180 - 10½"x72"



LES BOIS

COBOLO



V2

LIEVE VARIAZIONE
SLIGHT VARIATION

wall 60x120 PORFIDO 2.0
floor 40x120 COBOLO 2.0



LB085 COBOLO 2.0
40x120 - 16"x48"



LB130 COBOLO 2.0
20x120 - 8"x48"



LES BOIS

SLAVONIA



V2
LIEVE VARIAZIONE
SLIGHT VARIATION

floor 26,5x180 SLAVONIA 2.0



8058 SLAVONIA 2.0
26,5x180 - 10½"x72"



LB081 SLAVONIA 2.0
40x120 - 16"x48"



LB126 SLAVONIA 2.0
20x120 - 8"x48"



LES BOIS

SARAWA



LIEVE VARIAZIONE
SLIGHT VARIATION

floor 26,5x180 SARAWA 2.0



8056 SARAWA 2.0
26,5x180 - 10½"x72"



LB082 SARAWA 2.0
40x120 - 16"x48"



LB127 SARAWA 2.0
20x120 - 8"x48"

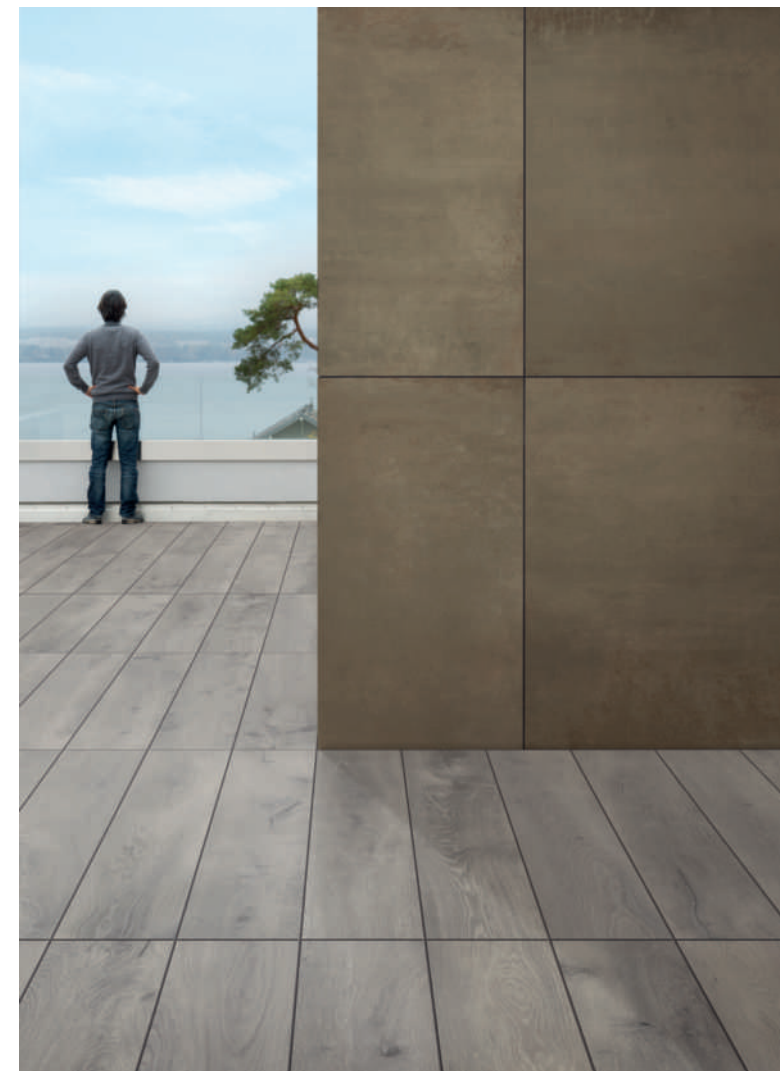

LES BOIS

CHEVRY



V2
LIEVE VARIAZIONE
SLIGHT VARIATION

floor 40x120 MIX DARK CHEVRY 2.0 | 40x120 SLAVONIA CHEVRY 2.0



LB088 MIX DARK CHEVRY 2.0
40x120 - 16"x48"



LB086 SLAVONIA CHEVRY 2.0
40x120 - 16"x48"



LB087 SARAWA CHEVRY 2.0
40x120 - 16"x48"



WOODSIDE

NUT



V3
MODERATA VARIAZIONE
MODERATE VARIATION

floor 26,5x180 NUT 2.0



8055 NUT 2.0
26,5x180 - 10 1/2"x72"



6683 NUT 2.0
20x120 - 8"x48"



6653 NUT DOGA 2.0
40x120 - 16"x48"



WOODSIDE

OAK



V3
MODERATA VARIAZIONE
MODERATE VARIATION

floor 26,5x180 OAK 2.0



8054 OAK 2.0
26,5x180 - 10½"x72"



6681 OAK 2.0
20x120 - 8"x48"



6651 OAK DOGA 2.0
40x120 - 15¾"x47½"



due centimetri

MONOLITICO PER ESTERNI

STONE

SKE2.0

FINITURA **PIETRA** / **STONE** EFFECT

53

NATIVA



LUX VENA 2.0



LUX FALDA 2.0



AURUM VENA 2.0



AURUM FALDA 2.0



TIBUR VENA 2.0



TIBUR FALDA 2.0

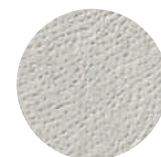

LUX ARMIS 2.0



AURUM ARMIS 2.0

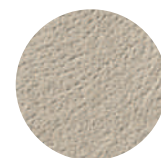

TIBUR ARMIS 2.0

PIASENTINA

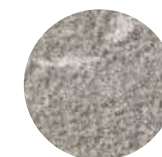

FALMED 2.0

EVOLUTION DU KRONOS



EVO NOIR 2.0

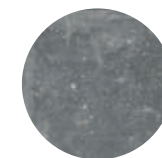

EVO GRIS FONCE 2.0



EVO GREYGE 2.0

LE REVERSE

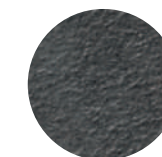

NUIT 2.0

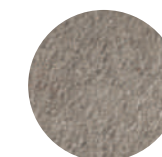

TAUPE 2.0

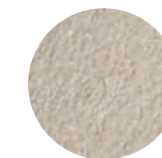

DUNE 2.0



OPAL 2.0

CARRIERE DU KRONOS



NAMUR 2.0



GENT 2.0



BRUGES 2.0

ROCKS

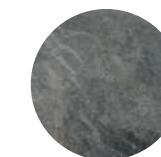

SILVER BLACK 2.0

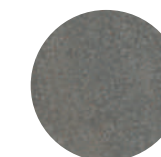

PORFIDO 2.0



floor
60x120 - 80x80 - 60x60
DUNE CARVED 2.0

wall
29x120
BAGUETTE BOCOTE

table
DUNE ELEGANCE

planter
80x80
DUNE CARVED

kitchen top
60x120
DUNE CARVED



colori inalterati nel tempo

unchanged colors over the time



floor
60x120
OPAL CARVED 2.0

wall
60x120
OPAL CARVED

NATIVA

LUX VENA
LUX FALDA



MODERATA VARIAZIONE
MODERATE VARIATION

wall 80x180 LUX VENA 2.0



NA066 LUX VENA 2.0
80x180 - 32"x72"



NA069 LUX VENA 2.0
60x120 - 24"x48"



NA072 LUX FALDA 2.0
NA081 LUX FALDA 2.0 *
60x120 - 24"x48"



NA075 LUX FALDA 2.0
NA084 LUX FALDA 2.0 *
60x60 - 24"x24"

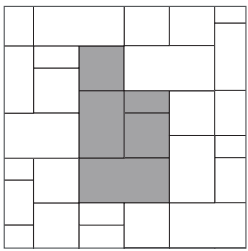

NA078 LUX FALDA 2.0
NA087 LUX FALDA 2.0 *
Modulo 120

* HERITAGE



NATIVA

AURUM VENA
AURUM FALDA



MODERATA VARIAZIONE
MODERATE VARIATION

floor 80x180 AURUM VENA 2.0



NA065 AURUM VENA 2.0
80x180 - 32"x72"



NA068 AURUM VENA 2.0
60x120 - 24"x48"



NA071 AURUM FALDA 2.0
NA080 AURUM FALDA 2.0 *
60x120 - 24"x48"



NA074 AURUM FALDA 2.0
NA083 AURUM FALDA 2.0 *
60x60 - 24"x24"

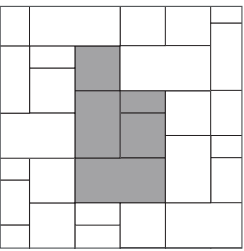

NA077 AURUM FALDA 2.0
NA086 AURUM FALDA 2.0 *
Modulo 120

* HERITAGE



NATIVA

TIBUR VENA
TIBUR FALDA



MODERATA VARIAZIONE
MODERATE VARIATION

floor modulo 120 TIBUR FALDA HERITAGE 2.0



NA064 TIBUR VENA 2.0
80x180 - 32"x72"



NA067 TIBUR VENA 2.0
60x120 - 24"x48"



NA070 TIBUR FALDA 2.0
NA079 TIBUR FALDA 2.0 *
60x120 - 24"x48"



NA073 TIBUR FALDA 2.0
NA082 TIBUR FALDA 2.0 *
60x60 - 24"x24"

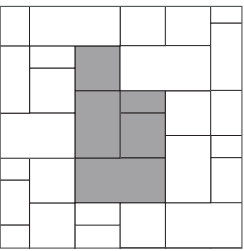

NA076 TIBUR FALDA 2.0
NA085 TIBUR FALDA 2.0 *
Modulo 120

* HERITAGE

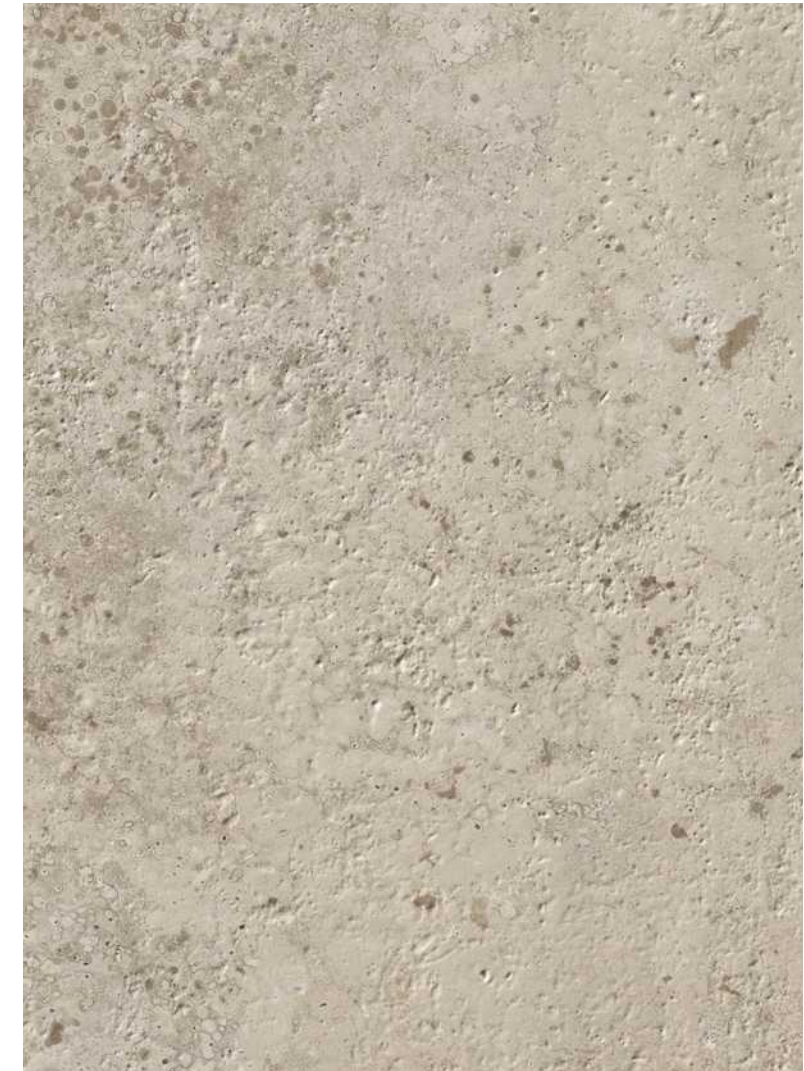

NATIVA

ARMIS



V3
MODERATA VARIAZIONE
MODERATE VARIATION

floor&stair 80x180 LUX ARMIS 2.0



NA090 LUX ARMIS 2.0
80x180 - 32"x72"

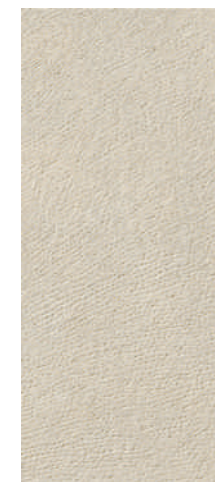

NA089 AURUM ARMIS 2.0
80x180 - 32"x72"



NA088 TIBUR ARMIS 2.0
80x180 - 32"x72"

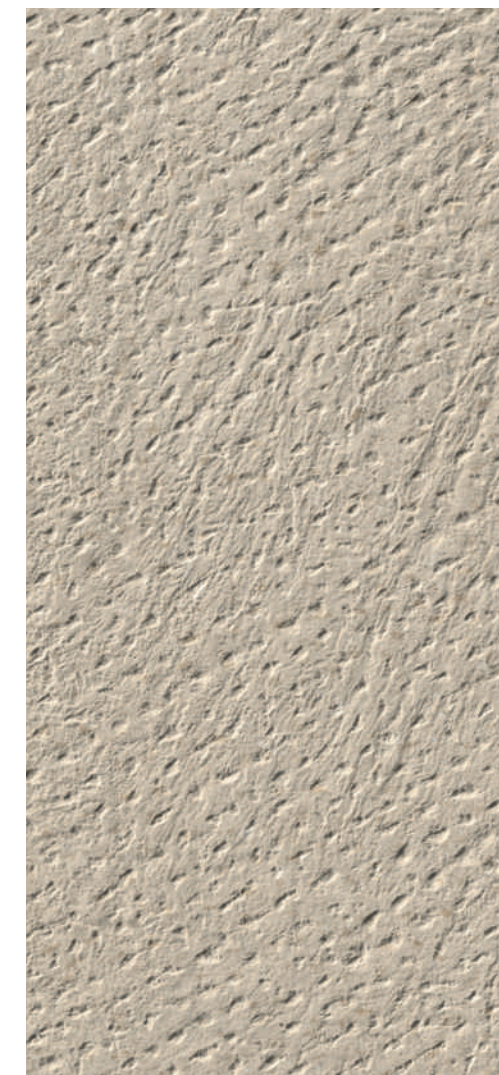

PIASENTINA

FLAMED



MODERATA VARIAZIONE
MODERATE VARIATION

floor 80x180 AURUM VENA 2.0



PS010 FLAMED 2.0
80x180 - 32"x72"



PS012 FLAMED 2.0
40x180 - 16"x72"



PS011 FLAMED 2.0
60x120 - 24"x48"



PS017 FLAMED 2.0
40x120 - 16"x48"



PS013 FLAMED 2.0
60x60 - 24"x24"



PS018 FLAMED 2.0
40x60 - 16"x24"

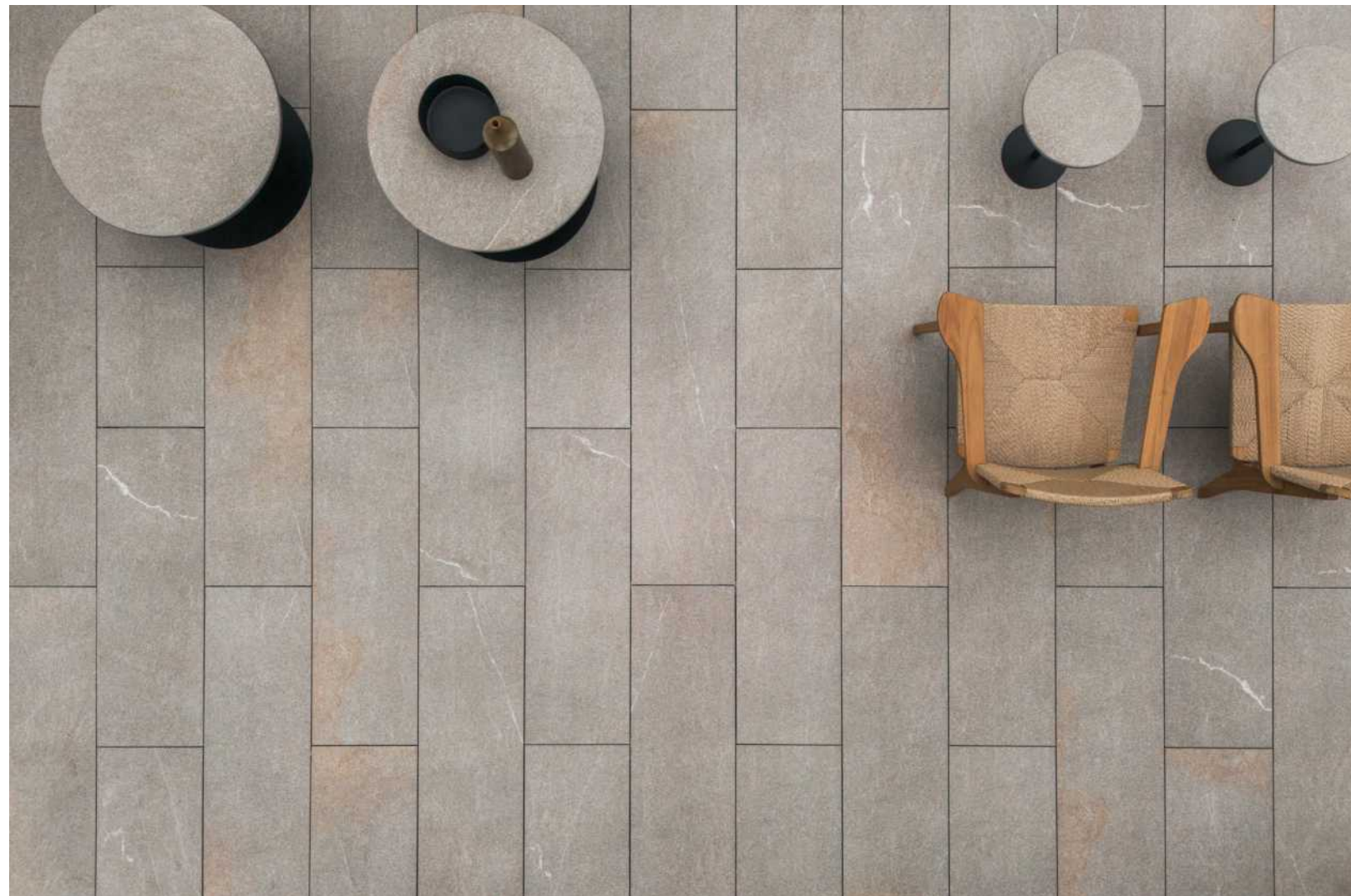

EVOLUTION DU KRONOS

EVO NOIR



V3

MODERATA VARIAZIONE
MODERATE VARIATION

outdoor floor 100x100 EVO NOIR **indoor floor** 100x100 EVO NOIR 2.0



EV010 EVO NOIR 2.0
100x100 - 40"x40"



EVOLUTION DU KRONOS

EVO GRIS FONCE



V3

MODERATA VARIAZIONE
MODERATE VARIATION

floor 100x100 EVO GRIS FONCE 2.0

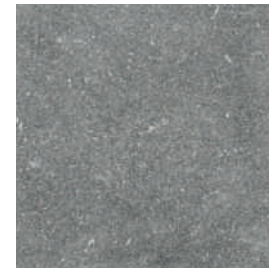

EV011 EVO GRIS FONCE 2.0
100x100 - 40"x40"

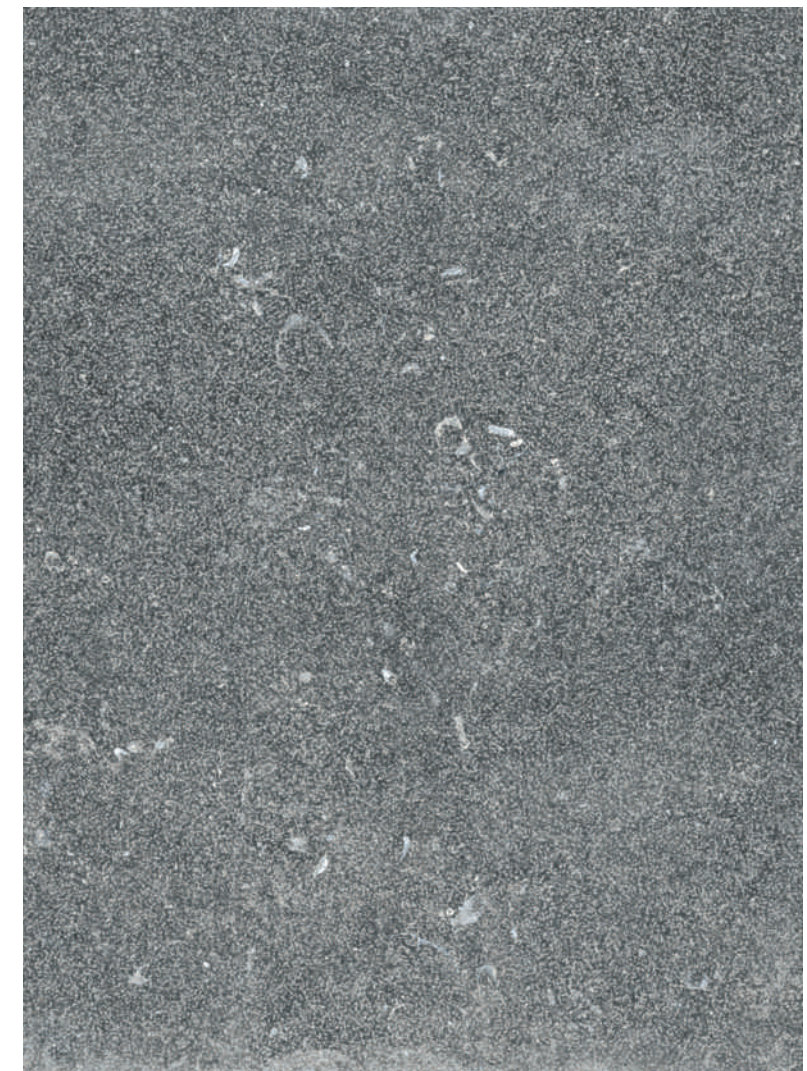

EVOLUTION DU KRONOS

EVO GREYGE



MODERATA VARIAZIONE
MODERATE VARIATION

outdoor floor 100x100 EVO GREYGE 2.0 **indoor floor** 100x100 EVO GREYGE



EV012 EVO GREYGE 2.0
100x100 - 40"x40"



LE REVERSE

NUIT



V3
MODERATA VARIAZIONE
MODERATE VARIATION

floor 80x80 NUIT CARVED 2.0

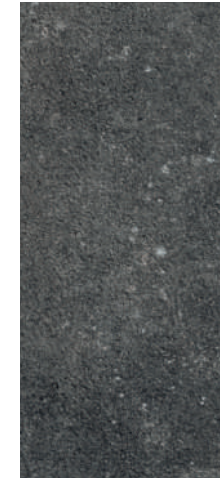

8039 NUIT CARVED 2.0
80x180 - 32"x72"

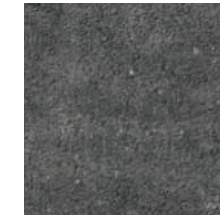

RS189 NUIT CARVED 2.0
80x80 - 32"x32"



RS184 NUIT CARVED 2.0
60x120 - 24"x48"

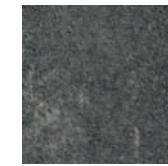

RS179 NUIT CARVED 2.0
60x60 - 24"x24"



LE REVERSE

TAUPE



MODERATA VARIAZIONE
MODERATE VARIATION

floor and stairs 60x120 TAUPE CARVED 2.0



RS188 TAUPE CARVED 2.0
80x80 - 32"x32"

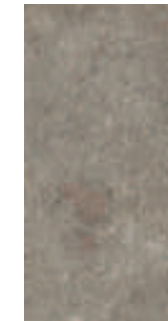

RS183 TAUPE CARVED 2.0
60x120 - 24"x48"



RS178 TAUPE CARVED 2.0
60x60 - 24"x24"



LE REVERSE

DUNE



V3
MODERATA VARIAZIONE
MODERATE VARIATION

floor 80x80 DUNE CARVED 2.0



RS187 DUNE CARVED 2.0
80x80 - 32"x32"



RS182 DUNE CARVED 2.0
60x120 - 24"x48"



RS177 DUNE CARVED 2.0
60x60 - 24"x24"



LE REVERSE

OPAL



V3
MODERATA VARIAZIONE
MODERATE VARIATION

floor 60x120 OPAL CARVED 2.0
swimming pool edge OPAL CARVED 2.0



RS186 OPAL CARVED 2.0
80x80 - 32"x32"



RS181 OPAL CARVED 2.0
60x120 - 24"x48"



RS176 OPAL CARVED 2.0
60x60 - 24"x24"



CARRIERE DU KRONOS

NAMUR



V3

MODERATA VARIAZIONE
MODERATE VARIATION

floor 60x60 NAMUR 2.0



8355 NAMUR 2.0
60x60 - 24"x24"

BLOCK2.0



9505 NAMUR 2.0
20,2x30,4 - 8"x12"



9500 NAMUR 2.0
20,2x20,2 - 8"x8"



CARRIERE DU KRONOS

GENT



V3

MODERATA VARIAZIONE
MODERATE VARIATION

floor 80x80 GENT 2.0



8356 GENT 2.0
60x60 - 32"x32"

BLOCK2.0



9506 GENT 2.0
20,2x30,4 - 8"x12"



9501 GENT 2.0
20,2x20,2 - 8"x8"



CARRIERE DU KRONOS

BRUGES



V3
MODERATA VARIAZIONE
MODERATE VARIATION

floor 60x60 BRUGES 2.0



8357 BRUGES 2.0
60x60 - 32"x32"

BLOCK2.0



9507 BRUGES 2.0
20,2x30,4 - 8"x12"



9502 BRUGES 2.0
20,2x20,2 - 8"x8"



ROCKS

PORFIDO



V2
LIEVE VARIAZIONE
SLIGHT VARIATION

wall 120x240 PORFIDO 2.0 floor 80x180 PORFIDO 2.0



8037 PORFIDO 2.0
80x180 - 32"x72"



8097 PORFIDO 2.0
40x120 - 16"x48"

BLOCK2.0



9515 PORFIDO 2.0
20,2x30,4 - 8"x12"



9510 PORFIDO 2.0
20,2x20,2 - 8"x8"



ROCKS

SILVER BLACK



V4
FORTE VARIAZIONE
SUBSTANTIAL VARIATION

floor 26,5x180 OAK 2.0
pool SILVER BLACK 2.0 bordo a L



7366 SILVER BLACK 2.0
60x120 - 24"x48"

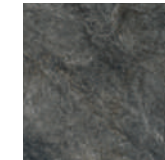

7361 SILVER BLACK 2.0
60x60 - 24"x24"



SKE2.0

caratteristiche tecniche TECHNICAL CHARACTERISTICS

Economico, leggero, ingelivo, antiscivolo (R11), ignifugo, isolante termico, removibile è il prodotto ideale per esterni residenziali come patio, terrazze, gazebo, piscine, giardini, vialetti, scale, balconi, solai; o commerciali come distese estive di bar e ristoranti, aree esterne di centri benessere, piscine, zone balneari, camminamenti.

SKE Monolitico 2.0 è un'innovativa soluzione realizzata in gres fine porcellanato di spessore 2cm. Consente di creare un piano di calpestio autoportante e senza incollaggi dalle ottime rese estetiche e tecniche, senza lavorazioni aggiuntive, come rinforzi. Rappresenta il prodotto ideale per la sopraelevazione, garantendo traffici medio pesanti (Classe 3).

Affordable, light, frost-proof, anti-slip (R11), flame resistant, heat insulator, removable is ideal both for residential outdoor, such as patios, terraces, gazebos, swimming-pools, gardens, garden paths, stairs, balconies, attics, and for commercial outdoor such as bar and restaurant' dehors, spa's exterior, swimming-pools, beach resorts and walkways.

SKE 2.0 slab is an innovative solution made of fine gres porcelain stoneware, 2cm thickness.

It creates a free-standing and not glued floor with an excellent aesthetic and technical performances without additional processing, such as reinforcement.

SKE 2.0 slab stands for the ideal product for pedestal set, assuring medium to heavy traffic (Class 3).

CLASSI DI CARICO DI ESERCIZIO
LOAD-BEARING CLASSIFICATION $\geq 3 \text{ kN}$

 **2CM**

perché scegliere 2 centimetri?

WHY CHOOSE 2 CM?

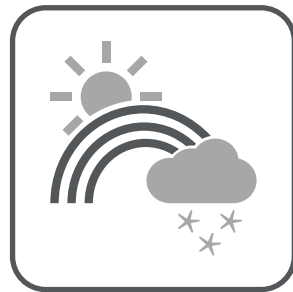

Resistenza agli sbalzi termici.

Thermal shock resistance.



Resistenza al gelo.

Frost resistance.



Resistenza al fuoco.

Fire resistance.

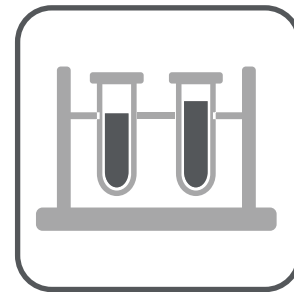

Resistenza alle macchie, acidi e prodotti chimici.

Resistant to stains, acid and chemicals.

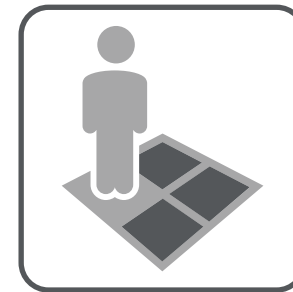

Facile da posare.

Easy to install.

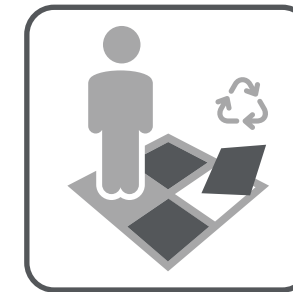

Rimovibile e riutilizzabile.

Removable and reusable.

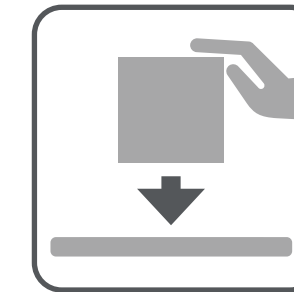

Installazione versatile. Varie possibilità di posa, quali sopraelevata, su erba, e su fondo morbido.

Versatile installation. Various installation methods including pedestal set, grass and gravel.

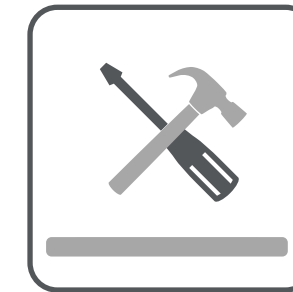

Nessuna manutenzione.

Virtually no maintenance.

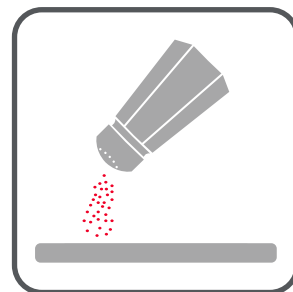

Resistenza alla corrosione del sale.

Resistant to corrosion from salt.



Resistenza alla muffa, muschio e trattamenti verdegama.

Resistant to attack from mould, moss and verdigris treatments.



Resistenza alla fioritura e all'insorgere di aloni.

Resistant to florescence and formation of dark halos.

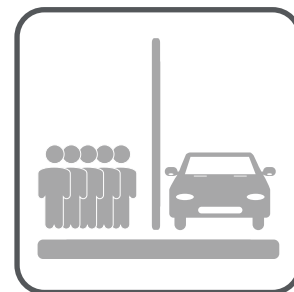

Durevole: resistenza all'alto traffico pedonale e su ruota.

Durable: withstands heavy foot and wheel traffic.



Facile da pulire.

Easy to clean.



Resistenza allo scivolamento.

Slip resistance.

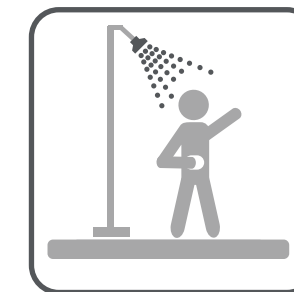

Utilizzo in contesti asciutti, bagnati e sommersi.

Dry, wet, and submerged applications.

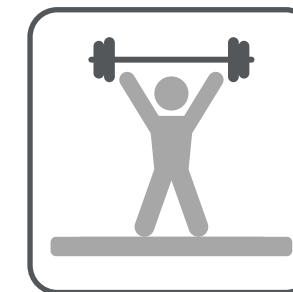

Resistenza ai carichi di rottura.

High breaking load.

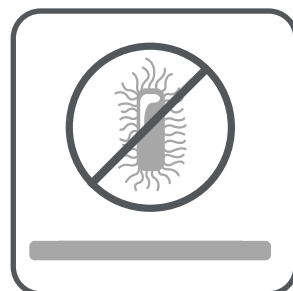

Ipoallergenico. Non rilascia inquinanti.

Hypoallergenic. No VOC.



Facile da sterilizzare.

Easy to sterilize.



Manutenzione ecologica.

Eco-friendly maintenance.



Riciclabile ed ecologico.

Recyclable and ecological.

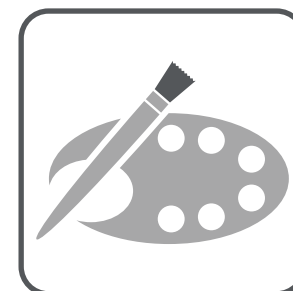

Colori inalterati nel tempo.

Colors remains unchanged over time.



Disponibile in un'ampia gamma di colori/finiture.

Available in a broad range of colors/styles.

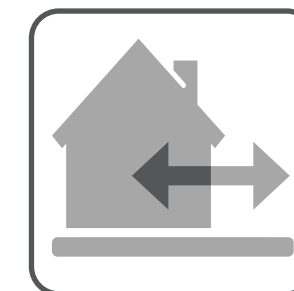

Uso esterno + interni coordinati + pezzi speciali come bordi piscina e scalini.

Outdoor application + coordinated indoors + special pieces such as pool edges and steps.



Importante risparmio grazie all'eccezionale ciclo di vita del prodotto.

Exceptional life cycle-cost = best value.

perché scegliere la posa sopraelevata?

WHY CHOOSE RAISED FLOOR?

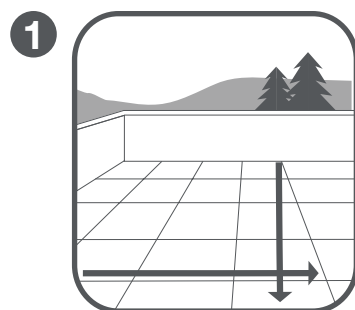

Dal punto di vista estetico, consente di ottenere pavimentazioni continue ad un'unica pendenza, senza corpi di recupero a vista per l'acqua (come griglie o scarichi).

From an aesthetic point of view, it allows for planar and uniform surfaces with no uneven levels or visible water drainage systems (grids or water discharge pipes).

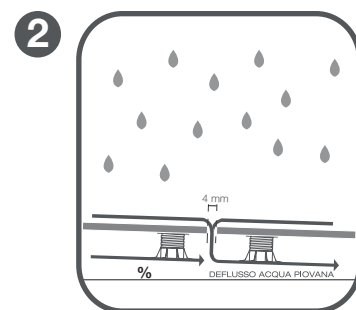

Il leggero spazio tra un pannello e l'altro consente un rapido e adeguato deflusso delle acque in eccesso. Facile da pulire. (Vedi pulizia e manutenzione / consigli di posa a pag. 102.)

The slight gap between gres slabs allows a quick water drainage. Easy to clean. (See cleaning and maintenance / laying instruction at page 102.)

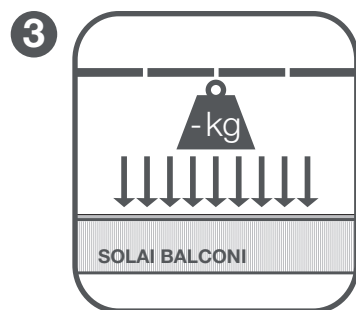

Minor carico su solai e balconi, evitando l'ultimo strato di caldana e colla.

Less load bearing in attics and on balconies as the last layer of concrete and glue is not necessary.

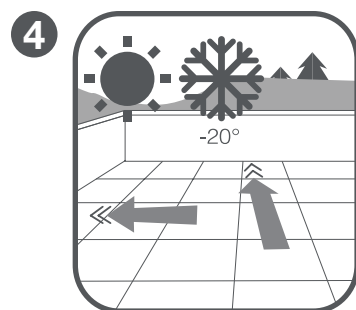

Ingelivo, assorbe le dilatazioni termiche della soletta, causa diretta dei cedimenti delle pavimentazioni esterne posate tradizionalmente.

Frost resistant, it absorbs the thermal expansions of the concrete substrate, the direct cause of traditional external flooring subsidences.

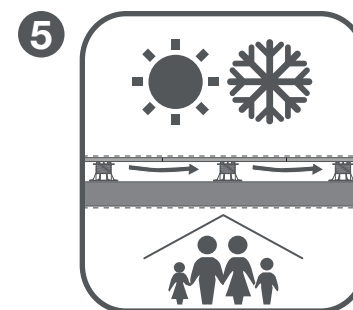

L'intercapedine tra pavimento e soletta favorisce il miglior isolamento termico.

The gap between the floor and the concrete substrate fosters thermal insulation.

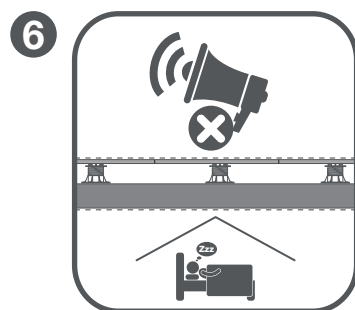

Favorisce l'isolamento acustico.

Best acoustic insulation.

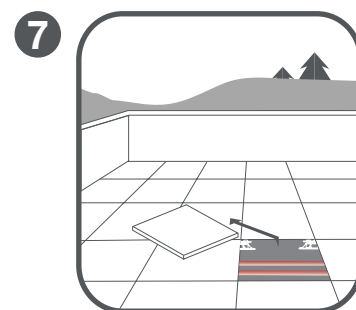

Tubazioni nascoste ma facilmente ispezionabili.

Hiding pipes but easy to inspect.

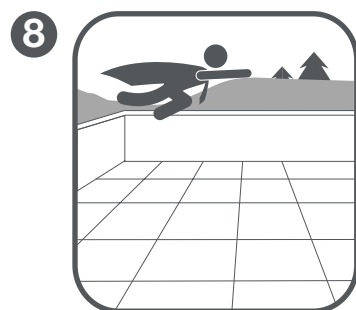

Velocità di posa.

Speed of installation.

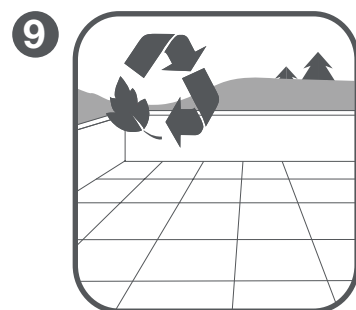

Riciclabile.

Recyclable.

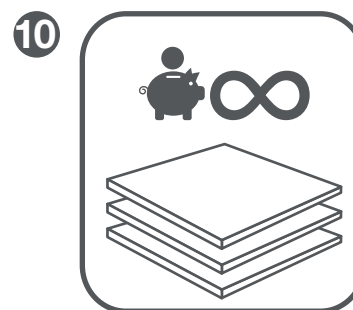

Garanzia di costi inferiori di posa e manutenzione, durata sostanzialmente eterna.









Value for money solution in terms of laying and maintenance, durable over time.

floor
60x60
GREIGE 2.0

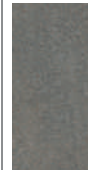
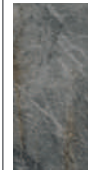
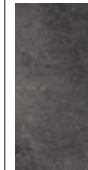

RANGE

SKE2.0

COLORS		STONE FINITURA PIETRA											
		EVOLUTION DU KRONOS			LE REVERSE				ROCKS		CARRIERE DU KRONOS		
													
EVO GREYGE	EVO GRIS FONCE	EVO NUIT	NUIT	TAUPE	DUNE	OPAL	PORFIDO	SILVER BLACK	NAMUR	GENT	BRUGES		
SIZES	80x180 32"x72"				8039 nuit 2.0 80x180				8037 porfido 2.0 80x180				
	60x120 24"x48"				RS184 nuit 2.0 60x120	RS183 taupe 2.0 60x120	RS182 dune 2.0 60x120	RS181 opal 2.0 60x120		7366 s. black 2.0 60x120			
<small>FORMATI CONSIGLIATI PER POSA SOPRAELEVATA CON AREA+ RECOMMENDED SIZES FOR RAISED FLOORS WITH "AREA+" SYSTEM</small>	40x180 16"x72"												
	40x120 16"x48"								8097 porfido 2.0 40x120				
	26,5x180 10½"x72"												
	20x120 8"x48"												
	100x100 40"x40"	EVO12 evo greyge 2.0 100x100	EVO11 evo gris fonce 2.0 100x100	EVO10 evo nuit 2.0 100x100									
	80x80 32"x32"				RS189 nuit 2.0 80x80	RS188 taupe 2.0 80x80	RS187 dune 2.0 80x80	RS186 opal 2.0 80x80					
	60x60 24"x24"				RS179 nuit 2.0 60x60	RS178 taupe 2.0 60x60	RS177 dune 2.0 60x60	RS176 opal 2.0 60x60	7361 s. black 2.0 60x60	8355 namur 2.0 60x60	8356 gent 2.0 60x60	8357 bruges 2.0 60x60	
	40x60 16"x24"												
	MODULO 120												
BLOCK2.0	20,2x30,4 8"x12"								9515 porfido 2.0 20,2x30,4	9505 namur 2.0 20,2x30,4	9506 gent 2.0 20,2x30,4	9507 bruges 2.0 20,2x30,4	
	20,2x20,2 8"x8"								9510 porfido 2.0 20,2x20,2	9500 namur 2.0 20,2x20,2	9501 gent 2.0 20,2x20,2	9502 bruges 2.0 20,2x20,2	

STONE FINITURA PIETRA									
NATIVA									PIASENTINA
									
LUX VENA	LUX FALDA	AURUM VENA	AURUM FALDA	TIBUR VENA	TIBUR FALDA	LUX ARMIS	AURUM ARMIS	TIBUR ARMIS	FLAMED
NA066 lux vena 80x180		NA065 aurum vena 80x180		NA064 tibur vena 80x180		NA090 lux armis 80x180	NA089 lux armis 80x180	NA088 tibur armis 80x180	PS010 flamed 80x180
NA069 lux vena 60x120	NA072 NA081* lux falda 60x120	NA068 aurum vena 60x120	NA071 NA080* aurum falda 60x120	NA067 tibur vena 60x120	NA070 NA079* tibur falda 60x120				PS011 flamed 60x120
									PS012 flamed 40x180
									PS017 flamed 40x120
	NA075 NA084* lux falda 60x60		NA074 NA083* aurum falda 60x60		NA073 NA082* tibur falda 60x60				PS013 flamed 60x60
									PS018 flamed 40x60
	NA078 NA087* lux falda MODULO 120		NA077 NA086* aurum falda MODULO 120		NA076 NA085* tibur falda MODULO 120				

* HERITAGE

IMBALLI_PACKAGING_EMBALLAGES_VERPACKUNGEN

	Thickness	Pezzi per scatola	M² per scatola	Kg per scatola	Scatole per pallet
80x180 - 32"x72" nativa piasentina le reverse rocks prima materia	20	1	1,44	67,00	20
40x180 - 16"x72" nativa piasentina le reverse rocks terra crea	20	1	0,72	33,4	40
26,5x180 - 10½"x72" essence les bois wood side	20	2	0,96	44,00	30
100x100 - 40"x40" evolution	20	1	1,00	47,50	21
modulo 120 nativa	20	1	0,72	33,40	30
80x80 - 32"x32" le reverse prima materia terra crea	20	2	1,28	58,50	24
60x120 - 24"x48" terra crea	20	1	0,72	33,00	30
60x120 - 24"x48" le reverse rocks	20	1	0,72	33,40	30
40x120 - 16"x48" piasentina rocks	20	2	0,96	41	24
60x60 - 24"x24" piasentina terra crea le reverse rocks	20	2	0,72	32,00	30
60x60 - 24"x24" carriere du kronos prima materia	20	2	0,72	33,00	30
40x60 - 16"x24" piasentina	20	2	0,48	33,4	48
20x120 - 8"x48" prima materia les bois	20	3	0,72	32,00	24
20x120 - 8"x48" woodside	20	3	0,72	31,50	24
BLOCK 2.0 20,2x20,2 - 8"x8"	20	12	0,49	22,50	54
BLOCK 2.0 20,2x30,4 - 8"x12" ^{mm}	20	7	0,43	20,00	60

indicazioni di posa LAYING INSTRUCTION

Posa 2 cm in esterno

Consequentemente alla dimensioni e natura delle lastre in gres porcellanato, alla forma pronunciata del rilievo antiscivolo (che trattiene sempre un velo di acqua), particolare attenzione deve essere data alla % di pendenza e inclinazione, che il cliente vuole dare al piano pavimento nonché alla direzione di posa della lastra in gres. La % di inclinazione e pendenza della pavimentazione deve soddisfare le scelte architettoniche del progetto e le naturali necessità di deflusso delle acque meteoriche. Queste ultime variano in funzione alla zona geografica, all'orientamento ed esposizione della zona interessata, se è completamente scoperta ecc. A titolo esemplificativo e non vincolante l'ufficio UPI svizzero consiglia pendenze non inferiori all'1,5% per metro lineare.

Doghe pre fugate SKE 2.0 e Preinciso Exter 60 x 60 (1 cm)
Consequentemente alla particolare struttura (basso rilievo preinciso) che riproduce un effetto doghe pre fugate, le dimensioni delle doghe esterne di ogni pezzo possono avere minime differenze dalle doghe interne. Questo dovuto al calibro di produzione che può avere variazioni dimensionali significative ad ogni produzione. Purtroppo questa variazione influenza solo le doghe esterne. Per questo motivo i prodotti in oggetto devono avere delle minime tolleranze estetiche, per migliorare le quali possiamo consigliare le seguenti contromisure: <p>1.Utilizzare Piedini con crocette di almeno 4 mm, così da avere la stessa dimensione per la fuga (SKE 2.0). Nella posa tradizionale utilizzare crocette sempre di 4 mm (che in sostanza si tratta di ripetere lo stesso dimensionamento delle fughe interne al pezzo).</p> <p>2. Posare il materiale seguendo sempre lo stesso verso di produzione (verificabile dal tampono).</p> <p>3. Adottare lo schema di posa a cesto.</p>

Effetti sulle superfici delle dilatazioni termiche
Le forti escursioni termiche (-15° +70° nelle nostre zone) alle quali sono soggette le COPERTURE PIANE, comportano la necessità di considerarne gli effetti sui materiali da costruzione. Materiali che hanno spesso tra loro differente COEFFICIENTE TERMICO DI DILATAZIONE. Le NORMATIVE prevedono la realizzazione di appositi GIUNTI ELASTICI DI DILATAZIONE nelle strutture costruttive, nel perimetro ed nel frazionamento delle solette. <p>Le nostre Pavimentazioni oltre ad avere un PROPRIO COEFFICIENTE TERMICO DI DILATAZIONE e un loro comportamento dinamico, poggiano e vengono pertanto installate su sottofondi e strutture che si muovono. Essi si CONTRAGGONO e si DILATANO in misura anche importante a seconda delle dimensioni per diversi CM. L'effetto che si potrebbe riscontrare anche in relazione alle zone di utilizzo delle pavimentazioni a secco è quello di un disallineamento delle fughe nel Sopraelevato o di sganciamento dei pezzi nel Modulo. Se fossero invece pavimentazioni incollate esse si potrebbero rompere e deteriorarsi.</p> <p>È pertanto indispensabile evitare/limitare l'insorgere di tali inestetismi, eseguendo un abbondante giunto perimetrale ed evitando, ove possibile lo stazionamento di forti pesi/strutture che impedirebbero il corretto movimento della pavimentazione. È indispensabile frazionare la pavimentazione nel caso del Modulo Plastico anche in corrispondenza del cambio di pendenza della soletta.</p> <p>A tale scopo, si consiglia l'uso degli accessori previsti nel catalogo e dei giunti elastici/coprigiunti reperibili normalmente, presso le rivendite specializzate.</p>

Raccomandazioni per la posa sopraelevata del SKE 2.0
Il prodotto Monolitico SKE 2.0 auto portante è sicuramente IDONEO all'uso in esterno per appoggio e soprelevazione. Non esiste una normativa "specificata" per i prodotti da esterno in gres in sopraelevazione, la più vicina al nostro prodotto è quella relativa ad i manufatti in cemento. A tale normativa il nostro prodotto SKE 2.0 RISPONDE IN MODO MIGLIORATIVO su tutti i test comparativi, ad esempio resiste a +1400 kg per piastra (risultato del test al carico di rottura come da norma EN 1339 KN > 14). <p>Questo vuole dire secondo lo standard adottato, che il materiale è idoneo "ALL'UTILIZZO COLLETTIVO e PUBBLICO SENZA LIMITAZIONE DELL'ALTEZZA DEI PIEDINI o TRAVERSINE". Se confrontiamo invece il nostro prodotto SKE 2.0 con la normativa da sopraelevato da "INTERNO" il suo PUNTO DEBOLE è la RESISTENZA AL CARICO/URTO DINAMICO da CORPO DURO (caduta di un martello o materiale rigido di almeno 4,5 kg da 40 cm di altezza) EN 12825. Infatti la particolare rigidità del gres a questo tipo di test non ci aiuta, perché la piastra può rompersi o frantumarsi, bisogna pertanto considerare questo rischio e a fronte di ciò consigliare in alcune destinazioni d'uso come officine meccaniche o dove le altezze del pavimento sono superiori ai 10 cm l'utilizzo di protezioni da applicare sul retro delle piastre:</p> <ul style="list-style-type: none">- vaschetta metalica sovrapposta - vaschetta metalica incollata - protezione in fibra incollata <p>Tali applicazioni non aumentano la portata del pavimento, ma sono solo la garanzia contro lo sfondamento e vanno a limitare il rischio di infortunio.</p>

Sollewamento causa vento
Nota bene: nella posa sopraelevata il materiale è stabile grazie al suo peso e alla forza di gravità. È possibile che si possa verificare un sollewamento in circostanze atmosferiche gravose, quali forte vento e tornado. Importante quindi che il progettista verifichi la posizione della pavimentazione rispetto al vento e alla posizione geografica dell'intervento, e consequentemente deve prevedere soluzioni architettoniche e ancoraggi meccanici ai fini di annullare questa problematica nei contesti sopraindicati.

	Thickness	Pezzi per scatola	M² per scatola	Kg per scatola	Scatole per pallet
80x180 - 32"x72" nativa piasentina le reverse rocks prima materia	20	1	1,44	67,00	20
40x180 - 16"x72" nativa piasentina le reverse rocks terra crea	20	1	0,72	33,4	40
26,5x180 - 10½"x72" essence les bois wood side	20	2	0,96	44,00	30
100x100 - 40"x40" evolution	20	1	1,00	47,50	21
modulo 120 nativa	20	1	0,72	33,40	30
80x80 - 32"x32" le reverse prima materia terra crea	20	2	1,28	58,50	24
60x120 - 24"x48" terra crea	20	1	0,72	33,00	30
60x120 - 24"x48" le reverse rocks	20	1	0,72	33,40	30
40x120 - 16"x48" piasentina rocks	20	2	0,96	41	24
60x60 - 24"x24" piasentina terra crea le reverse rocks	20	2	0,72	32,00	30
60x60 - 24"x24" carriere du kronos prima materia	20	2	0,72	33,00	30
40x60 - 16"x24" piasentina	20	2	0,48	33,4	48
20x120 - 8"x48" prima materia les bois	20	3	0,72	32,00	24
20x120 - 8"x48" woodside	20	3	0,72	31,50	24
BLOCK 2.0 20,2x20,2 - 8"x8"	20	12	0,49	22,50	54
BLOCK 2.0 20,2x30,4 - 8"x12" ^{mm}	20	7	0,43	20,00	60

Laying 2 cm in outdoor
<i>Consequently, the size and nature of the porcelain stoneware slabs, due to the pronounced anti-slip surface (which always retains a thin layer of water), special attention should be given to the slope and inclination %, that the customer wants to give to the floor plan and direction laying of the slab stoneware. The % of slope and slope of the floor must meets the architectural choices of the project and the needs for natural runoff of rainwater. These vary according to the geographical area, orientation and exposure of the affected area, if it is completely bare, etc. etc. By way of example, not binding, of the Swiss office UPI, recommends slopes not less than 1, 5% per linear meter.</i>

The Doghe (grout staves) SKE 2.0 and "Struttura Exter" 60x60 (1 cm)
<i>Consequently the special structure (bas-relief grooves) which reproduces a wood grooves effect the exterior staves dimensions of each piece may have subtle differences from inner staves. This due to the caliber of production that can have significant dimensional variations to each production. Unfortunately this affects the outside slats only. For this reason the products concerned must have a minimum aesthetic tolerances, to improve then we may recommend the following countermeasures:</i> <ol style="list-style-type: none">To use pedestals with crosses of at least 4 mm in order to have the same size for the joint (SKE 2.0) In the traditional installation use crosses to 4 mm (the aim is repeating the same internal dimensioning leakage per piece). To lay down the material following always the same production (verifiable from the back of the slab) Adopt the basket diagram laying.

Effects on surface of thermal expansion
<i>The strong thermal excursions (-15° + 70°) which are subjected the FLAT ROOFS, involve the need to consider the effects on building materials. Materials that often have among their different COEFFICIENT of dilatation. The regulations provide for the establishment of special ELASTIC expansion JOINTS in building structures, in the perimeter and in the fractionation of insoles. Our Flooring as well as having its own THERMAL EXPANSION COEFFICIENT and their dynamic behavior, they lay down and are installed on foundations and structures that move. They contract and dilate in measure also important depending on the size even for some cm. The effect that you might encounter in relation to the use of dry flooring is a misalignment of joints in release of raised floor or uncoupling the plastic module. If they would be glued flooring instead, they might break and deteriorate. It is therefore essential to avoid or limiting the occurrence of these flaws, making a large perimeter joints and avoiding, where possible, the stationing of heavy weights/structures that inhibit the correct movement of the flooring. It is necessary to split up the flooring area in the case of plastic module also at the slope change of the base. To do this, it is advisable to use the accessories provided in the catalog and elastic joints/shackles available normally at specialty retailers.</i>

Recommendations for SKE2.0 on elevated installation
<i>The Monolithic product SKE self-carrying 2.0 is definitely suitable for external use for support and elevated installation. There is no specific legislation for outdoor products in porcelain in elevation, the closest to our product is relating to the cement slabs (concrete). To this legislation our SKE 2.0 RESPONDS IMPROVEMENT on all comparative tests, e.g. resists more then 1400 kg per slab (test result as per EN 1339 KN 14 >). This means, according to the adopted standard, the material is suitable for "COLLECTIVE and public use without LIMITATION of the height of the pedestals or sleepers". If we compare our product SKE 2.0 to the elevated indoor norms, his weakness point is the LOAD/DYNAMIC HARD body SHOCK (for example a hard object fall such as a hammer or other rigid material of less than 4.5 kg from 40 cm height) EN 12825. In fact the particular stiffness of the gres porcelain does not help us, because the gres slab can break or shatter, we must therefore consider this risk and in face of this advise in some uses such as mechanical workshop or where floor heights are higher than the 10 cm using reinforcements to be applied on the back of the slabs :</i> <ul style="list-style-type: none">-overlapping metal tray -metal tray stuck -glued fiber protection <i>These applications do not increase the floor weight capacity, but they are just a guarantee against breakage and limit the risk of accidents.</i>

Wind uplift
<i>Note: in case of pedestal set ,the gres porcelain slab is stable thanks to its weight and force of gravity. The bad weather, as strong wind and tornado , could uplift the slab. It is really important that the architect checks the position of the deck surface according to its geographical location and wind direction. He must figure out architectural solutions and mechanical anchorings to avoid the case underlined in the headline.</i>

CARATTERISTICHE E PROPRIETÀ CHARACTERISTICS OR PROPERTIES CARACTÉRISTIQUES OU PROPRIÉTÉS EIGENSCHAFTEN UND GÜTEMERKMALE	NORME STANDARDS NORMES NORMEN	SECONDO LE NORME COMPLIANCE WITH STANDARDS CONFORME AUX NORMES ENTSPRECHEND DEN NORMEN UNI EN 14411 G	
QUALITÀ DELLA SUPERFICIE - SURFACE QUALITY - QUALITÉ DE LA SURFACE - OBERFLÄECHENQUALITÄET	ISO 10545-2	IL 95% MIN DELLE PISTRELLE DEVE ESSERE ESENTE DA DIFETTI VISIBILI / AT LEAST 95% OF THE TILES MUST BE FREE FROM VISIBLE FLAWS / 95% MIN DES CARREUX NE DOIVENT PRÉSENTER AUCUN DÉFAUT VISIBLE / MINDESTENS 95% DER FLIESEN MÜSSEN FREI VON SICHTBAREN	CONFORME ALLE NORME - COMPLIES WITH STANDARD - CONFORME AUX NORMES - NORMGERECHT
	N ≥ 15cm %	N ≥ 15cm mm	RISULTATI TEST TEST RESULTS RESULTSTES DES ESSAIS PRÜFERGEBNIS

DEVIAZIONE MASSIMA DI RETTILINEITÀ IN % - MAXIMUM STRAIGHTNESS DEVIATION IN % - MARGE DE TOLÉRANCE DE RECTITUDE EN % - ZULAESSIGE HOECHSTABWEICHUNG DER KANTENGERADHEIT IN PROZENTEN	± 0,3 %	± 0,8 mm	± 0,10%	CONFORME ALLE NORME COMPLIES WITH STANDARD CONFORME AUX NORMES - NORMGERECHT
DEVIAZIONE AMMISSIBILE IN %, DELLO SPESSORE MEDIO DI OGNI PIASTRELLA DALLA DIMENSIONE DI FABBRICAZIONE - ADMITTED DEVIATION, IN %, OF THE AVERAGE THICKNESS OF EACH TILE FROM THE PRODUCTION DIMENSIONS - MARGE DE TOLERANCE, EN POURCENTAGE, ENTRE L'ÉPAISSEUR MOYENNE DE CHAQUE CARREAU ET LA DIMENSION DE FABRICATION - ZULÄSSIGE ABWEICHUNG DER DURCHSCHNITTSDICKE JEDER FLIESE VOM HERSTELLMASS IN PROZENTEN	± 5 %	± 0,5 mm	± 5%	CONFORME ALLE NORME COMPLIES WITH STANDARD CONFORME AUX NORMES NORMGERECHT
DEVIAZIONE MASSIMA DI ORTOGONALITÀ IN % - MAXIMUM RIGHT-ANGLE DEVIATION IN % MARGE DE TOLÉRANCE D'ANGULARITÉ IN % - HOECHSTABWEICHUNG DER RECHTWINKLIGKEIT IN PROZENTEN	± 0,3 %	± 1,5 mm	± 0,20%	CONFORME ALLE NORME COMPLIES WITH STANDARD CONFORME AUX NORMES - NORMGERECHT

PLANARITÀ - FLATNESS - PLANÉITÉ - EBENFLÄECHIGKEIT				
LUNGHEZZA E LARGHEZZA - LENGTH AND WIDTH LONGUEUR ET LARGEUR - LÄNGE UND BREITE				
ASSORBIMENTO D' ACQUA - WATER ABSORPTION ABSORPTION D'EAU - WASSERAUFNAHME	ISO 10545-3	≤ 0,5 %		E ≤ = 0,04 %
RESISTENZA ALLA FLESSIONE - BENDING STRENGTH RESISTANCE A LA FLEXION - BIEGEZUGFESTIGKEIT	ISO 10545-4	R ≥ 35 N/mm²		53 N/mm²
RESISTENZA ALL'URTO - IMPACT RESISTANCE RESISTANCE AUX CHOCs - SCHLAGFESTIGKEIT	ISO 10545-5	VALORE DICHIARATO - DECLARED VALUE - VALEUR DECLAREE - ANGEGEBENER WERT		0,88
RESISTENZA ALL'ABRASIONE PROFONDA - RESISTANCE TO DEEP ABRASION RESISTANCE A L'ABRASION PROFONDE - WINDERSTANDSFAKGEIT GEGEN TIEFENABRIEB	ISO 10545-6	≤175 mm³		<128 mm³
COEFF. DI DILATAZIONE TERMICA LINEARE - COEFFICIENT OF LINEAR THERMAL EXPANSION - COEFF. D'EXTENSION THERMIQUE LINEAIRE - LINEAR WÄRMEAUDEHNUNGS-KOEFFIZIENT	ISO 10545-8	-		α=7x10 ⁻⁶ /°C ⁻¹
RESISTENZA AGLI SBALZI TERMICI - THERMAL SHOCK RESISTANCE RESISTANCE AUX ECARTS THERMIQUES - TEMPERATURWECHSELBESTÄNDIGKEIT	ISO 10545-9	TEST SUPERATO SECONDO EN ISO 10545-1 - PASS ACCORDING EN ISO 10545-1 - TEST OBTENUS SELON EN ISO 10545-1 - TEST LAUT EN ISO 10545-1 BESTANDEN		NESSUN DANNO - NO DAMAGE - AUCUN DOMMAGE - KEIN SCHADEN

RESISTENZA AL GELO - FROST RESISTANCE RESISTANCE AU GEL - FROSTBESTÄNDIGKEIT	ISO 10545-12	TEST SUPERATO SECONDO EN ISO 10545-1 - PASS ACCORDING EN ISO 10545-1 - TEST OBTENUS SELON EN ISO 10545-1 - TEST LAUT EN ISO 10545-1 BESTANDEN		NESSUN DANNO - NO DAMAGE - AUCUN DOMMAGE - KEIN SCHADEN
RESISTENZA AGLI AGENTI CHIMICI - CHEMICAL RESISTANCE RESISTANCE A L'ATTAQUE CHIMIQUE - BÄSTÄNDIGKEIT GEGEN CHEMIKALIEN	ISO 10545-13	UB MIN.		UA ULA UHA
RESISTENZA ALLE MACCHIE - RESISTANCE TO STAIN RESISTANCE AUX TACHES - FLECKENFESTIGKEIT	ISO 10545-14	VALORE DICHIARATO - DECLARED VALUE VALEUR DECLAREE - ANGEGEBENER WERT		Classe 5
RESISTENZA AL FUOCO - FIRE RESISTANCE RESISTANCE AU FEU - FEUERWIDERSTAND	EN 13501 - 1	VALORE DICHIARATO - DECLARED VALUE VALEUR DECLAREE - ANGEGEBENER WERT		CLASSE A1 - A1 FL

RESISTENZA ALLO SCIVOLAMENTO - SLIP RESISTANCE RESISTANCE AU GLISSEMENT - BESTIMMUNG DER RUSTSCHEMMENDE EIGENSHAFT	ISO 10545-13	UB MIN.		UA ULA UHA
B.C.R. C.A. B.C.R. G.B <small>0.10. 236 DEL 4.6 1989</small>		> 0,40		CONF
ASTM C 1028/07 BOT 3000		Dry SCOF > 0,60		CONF
ASTM C 1028/07 BOT 3000		Wet SCOF > 0,60		CONF
ANSI A137.1 BOT 3000		Wet DCOF > 0,42		CONF
DIN 51130		-		R11
DIN 51097		-		A+B+C
ENV 12633		≥ CL 1		CONF
UNI EN 13036 - 4 2011		≥ 36		CONF

STABILITÀ DEI COLORI ALLA LUCE E AI RAGGI U.V. COLOUR STABILITY ON EXPOSURE TO LIGHT AND UV RAYS STABILITE DES COULEURS À LA LUMIÈRE ET AUX RAYONS U.V. FARBECHTHEIT UNTER LICHTEINLUSS UND UV-STRAHLUNG	DIN 51094	VALORE DICHIARATO - DECLARED VALUE - VALEUR DECLAREE - ANGEGEBENER WERT		CONFORME ALLE NORME. NO VARIAZIONI COMPLIES WITH STANDARD. NO VARIATION CONFORME AUX NORMES, PAS DE CHANGEMENTS NORMGERECHT, KEINE AENDERUNG
SKE2.0				
CARICO STATICO - STATIC LOAD CHARGE STATIQUE - STATISCHER BELASTUNG	EN 12825	VALORE DICHIARATO - DECLARED VALUE - VALEUR DECLAREE - ANGEGEBENER WERT		CENTRO - CENTRE 9,6 KN CENTRO LATO CENTRE POINT OF SIDES 6,5 KN DIAGONALE - DIAGONAL 8,19 KN (CLASSE 3)
CARICO DINAMICO, PROVA DI URTO DI CORPI DURI - DYMANIC LAOD CAPACITY, HAND OBJECT IMPACT TEST C. STATIQUE, ESSAI DE CHOC DE CORPS DURS - STATISCHER BELASTUNG, AUSWIRKUNGEN TEST DER HARTEN KÖRPER	EN 12825	VALORE DICHIARATO - DECLARED VALUE - VALEUR DECLAREE - ANGEGEBENER WERT		TEST NON SUPERATO - TEST NOT PASSED TEST A ÉCHOUE - TEST FEHLGESCHLAGEN
CARICO DINAMICO, PROVA DI URTO DI CORPI MORBIDI - DYMANIC LAOD CAPACITY, SOFT OBJECT IMPACT TEST C. STATIQUE, ESSAIS D'IMPACT DE CORPS MOUS - STATISCHER BELASTUNG, AUSWIRKUNGEN PRÜFUNG VON WEICHEN KÖRPERN	EN 12825	VALORE DICHIARATO - DECLARED VALUE - VALEUR DECLAREE - ANGEGEBENER WERT		TEST SUPERATO - TEST PASSED TEST REUSSI - TEST BESTANDEN
RESIENZA ALLA FLESSIONE, CARICO DI ROTTURA IN N - BENDIND STRENGTH, BREAKING FORCE IN N RESISTANCE A LA FLEXION, CHARGE DE ROPTURE IN N - BIEGEFESTIGKEIT, BRUCHLAST EN N	EN 1339	Kn 14,38		CLASSE U14
CARICO DI ROTTURA IN MPA - BREAKING FORCE IN MPA - CHARGE DE ROPTURE IN MPA - BRUCHLAST EN MPA		-		MPA 46,5



Kronos 2 ceramiche S.p.A.

Sede legale: Strada delle Fornaci, 20 41126 Modena Italy
Sede amministrativa: Via Giardini, 62 41042 Fiorano Modenese (Mo) Italy
tel. +39 0536 927711 - info@kronosceramiche.com
www.kronosceramiche.com

